

Blomberg[®]

seit 1883

Refrigerator User Manual



BRFB1920SS
BRFB1900FBI
BRFB1920FBI



Please read this manual before using the product!

Dear Valued Customer,



We wish you to get the best results from your product that has been manufactured meticulously at modern plants and tested with detailed quality control checks.

For this reason, we recommend that you read this user manual thoroughly before starting the product. If you hand over the product to someone else, please remember to give the user manual as well.

This manual will help you use your appliance in a fast and safe way.

- Please read this user manual carefully before installing and using the product.
- Always follow the applicable safety instructions.
- Keep the user manual in an easily accessible place for further use.
- Please read all the other documents provided with the product.

Please keep in mind that this manual may apply to several product models. This manual expressly indicates the differences between various models.

	Important information and useful hints.
	Risk of injury and property damage.
	Risk of electric shock.
	Packaging materials of this product has been manufactured from recyclable materials in accordance with the National Environment Regulations.

CONTENT

1 Important Instructions Regarding Safety and Environment	4	5 Operating the product	18
1.1 General Safety	4	5.1 Dual Cooling System	18
1.1.1 Hydrocarbon (HC) Warning	5	5.2 Freezing Fresh Food	18
1.1.2 For Products with a Water Dispenser/Ice Machine	5	5.3 Recommendations for Storing Frozen Food	18
1.2 Intended Use	5	5.4 Placing the Food	18
1.3 Children's Safety	6	5.5 Information About Deep Freezing	19
1.4 Compliance with the WEEE Directive and Disposing the Waste Product	6	5.6 Blue Light	20
1.5 Compliance with the RoHS Directive	6	5.7 Ioniser	20
1.6 Packaging Information	6	5.8 Description and Cleaning of the Odour Filter	20
2 Refrigerator	7	5.9 Door Open Warning	20
3 Display Appearance	8	5.10 Interior Lighting	20
3.1 On/Off Function	9	5.11 Sabbath Mode	21
3.2 General Display Appearance	9	5.12 Vacation Function	21
3.3 Fresh Food Compartment Setting Function	10	5.13 Water Filter	21
3.4 Quick Fridge Function	10	5.14 Water connection	22
3.5 Freezer Compartment Setting Function	11	5.15 Attaching/Removing the Internal Filter to/from the Refrigerator	22
3.6 Quick Freeze Function	11	5.16 Using the Internal Water Dispenser	24
3.7 Special Fridge Compartment	12	5.17 Water Dispensing	24
3.8 Eco Function	13	5.18 Before Using the Water/Ice Dispenser	25
3.9. Vacation Function	13	5.19 Icebox	25
3.10. Ice Machine	13	5.20 Door Shelves	26
3.11 Water Dispenser	14	5.21 Adjustable Door Shelf	26
3.12 Child Lock/Key Lock	14	5.22 Glass Shelves	26
3.13 Sabbath Mode	15	5.23 Motor Glass Shelves	27
3.14 Filter Reset	15	5.24 Humidity-Controlled Crisper	27
3.15 Temperature Unit Change Screen	16	5.25 Special Fridge Compartment	28
4 Preparation	17	5.26 Freezer Drawers	28
4.1 Things to Do for Energy Saving	17	5.27 Hinge Adjustment	29
4.2 Recommendations About the Fresh Food Compartment	17	5.28 Changing the Direction of the Door	29
4.3 Initial use	17	6 Care and cleaning	30
		6.1. Avoiding Bad Odours	30
		6.2. Protecting the Plastic Surfaces	30
		6.3 Cleaning the Inner Surface	31
		6.4 Stainless Steel Outer Surfaces	31
		7 Troubleshooting	32

1 Important Instructions Regarding Safety and Environment

This chapter contains safety information that will help you avoid the risk personal injury or property damage. Failure to follow these instructions shall render any product warranty void.

1.1 General Safety

- This product can be used by children at age 8 and above and those people who have limited physical, sensory or mental capabilities and people who lack experience and information on the condition that they have been given the instructions about the safe use of the product, they are supervised and the risks have been eliminated. Children should not play with the product. Cleaning and care should not be performed by children unless they are supervised by an adult.
- Unplug the product if you encounter a failure during use.
- If the product malfunctions, it must not be operated until repaired by the authorised service provider. Risk of electric shock!
- Plug the product into a grounded socket protected by a fuse that corresponds to the value on its nameplate. Have a qualified electrician ground the product. Our company cannot be held responsible for damages resulting from the failure to use the product with a grounded socket pursuant to local regulations.
- Unplug the product when not in use.
- Never wash the product by spreading or pouring water onto it! Risk of electric shock!
- Never touch the plug with wet hands!
- Never unplug the product by pulling the cable. Always pull the plug by holding the socket.

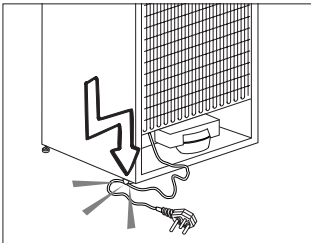

- Do not plug the refrigerator if the wall socket is loose.
- Never connect your refrigerator to energy saving devices. Such systems are harmful to your product.
- Unplug the product during installation, care, cleaning and repairing procedures.
- Always have the **Authorised Service Provider** install the product and establish its electrical connections. The manufacturer cannot be held responsible for damages caused by procedures performed by unauthorised persons.
- Do not eat cone ice cream or ice cubes immediately after you take them out of the freezer compartment! This may cause frostbite in your mouth!
- Do not touch frozen food with wet hands! They may stick to your hand!
- Do not put bottled or canned liquid beverages in the freezer compartment. They may burst!
- Never use steam or steam cleaners to clean or defrost the refrigerator. Steam gets into contact with the live parts in your refrigerator, causing short circuit or electric shock!
- Do not use mechanical devices or other means to accelerate the defrosting process other than those recommended by the manufacturer.
- Never use the parts in your refrigerator such as the door and drawer as a means of support or step. This may cause the product to tip over or damage the parts of it.
- Do not damage the parts where the refrigerant is circulating with drilling or cutting tools. The refrigerant that might blow out when the gas channels of the evaporator, pipe extensions or surface coatings are punctured causes skin irritations and eye injuries.
- Do not cover or block the ventilation holes in your refrigerator with any object.
- Place the beverage with higher proofs tightly closed and vertically.
- Do not use gaseous sprays near the product since there is the risk of fire or explosion!
- Flammable items or products that contain flammable gases (e.g. spray) as well as explosive materials should never be kept in the appliance.

Important instructions regarding safety and environment

- Do not place vessels filled with liquid onto the product. Splashing water on an electrical part may cause electric shock or the risk of fire.
- Do not store items that need precise temperature adjustment (such as vaccines, heat-sensitive medication, science materials etc.) in the refrigerator.
- If you are not going to use the product for a long time, unplug it and remove the food in it.
- If there is a blue light on the refrigerator, do not look at this light with optical tools.
- Exposing the product to rain, snow, sun or wind is dangerous in terms of electrical safety.
- In products with mechanical control (thermostat), wait for 5 minutes to plug in the product again after unplugging.
- Do not overload the refrigerator. Objects in the refrigerator may fall down when the door is opened, causing injury or damage. Similar problems may arise if any object is placed onto the product.
- If the product has a door handle, do not pull the handle when re-locating the product. The handle might be loose.
- Be careful not to jam your hand or any other body part in the moving parts of the refrigerator.
- Do not put your hand or any other foreign materials into the ice machine while it is operating.

1.1.1 Hydrocarbon (HC) Warning

- If your product's cooling system contains R600a:

This gas is flammable. Therefore, pay attention not to damage the cooling system or the piping during use and transportation. If damaged, keep the product away from potential fire sources that may cause it to catch fire and ventilate the room where the product is placed.



If the product is damaged and if you see gas leak, please keep away from the gas. It may cause frostbite when it gets into contact with the skin. (including R134)



Ignore this warning if the cooling system of your product contains R134a.



Type of gas used in the product is stated on the type plate which is on the left wall inside the refrigerator.



WARNING:

Never throw the product into fire for disposal.

1.1.2 For Products with a Water Dispenser/Ice Machine

- Operating pressure for cold water inlet is between 1-5.5 bars. If the water pressure exceeds 80 psi (5.5 bars), install a pressure limiting valve to your mains system. If the mains pressure is lower than 1 bar, you can use an auxiliary pump to compensate the low pressure. If you do not know how to check the water pressure, please consult a professional plumber.
- If there is a risk of water impact in your installation, always use a water impact protection equipment in that installation. Please consult professional plumbers if you are not sure if there is water impact in your installation.
- Do not make installation on the hot water inlet.
- Take the necessary measures against the freezing risk of the hoses. The water temperature operating range must be 0.6°C (33°F) minimum and 38°C (100°F) maximum.



WARNING:

Never connect the product to a cold water mains with a pressure of 5.5 bars (80 psi) and above.

1.2 Intended Use

- This product has been designed for domestic use. It is not suitable for commercial use and it must not be used out of its intended use.
- It must be used only for storing food.

Important instructions regarding safety and environment

- The manufacturer will not take any responsibility for damages resulting from improper use or transport.
- Original spare parts will be available for 10 years after the purchase date of the product.

1.3 Children's Safety

- If there is a lock on the door of the product, the key should be kept out of the reach of children.
- Do not let children play with the product.

	DANGER: Before disposing your old refrigerator or freezer:
	<ul style="list-style-type: none">• Children may get locked inside.• Remove the doors.• Leave the shelves to prevent children from getting inside the product easily.

1.4 Compliance with the WEEE Directive and Disposing the Waste Product:



This product conforms to the EU WEE Directive (2012/19 EU). This product bears a classification symbol for waste electrical and electronic equipment (WEEE). This product has been manufactured from high quality parts and materials which can be reused and are suitable for recycling. Therefore, do not dispose the product with normal domestic waste or other waste at the end of its service life. Take it to a collection centre for recycling electrical and electronic equipment. Please consult local authorities to learn about the locations of such collection centres.

1.5 Compliance with the RoHS Directive:

The unit you have purchased conforms to the EU RoHS Directive (2011/65/AB). It does not contain harmful or prohibited materials specified in the Directive.

1.6 Packaging Information

- Packaging materials of the product have been manufactured from recyclable materials in accordance with our National Environment Regulations. Do not dispose the packaging materials with normal domestic waste or other types of waste. Take these materials to a recycling point designated by local authorities.

	DANGER: Risk of Fire or Explosion:
	<ul style="list-style-type: none">• This product uses flammable refrigerant.• Do not use mechanical devices to defrost the refrigerator.• Do not use chemicals for cleaning.• Do not pierce the refrigerant pipe.• If the refrigerant pipe is pierced, it must be repaired only by licensed service personnel.• Please consult the repair/user manual before cleaning the product. All safety instructions must be followed.• Dispose the product according to federal or local regulations.

2 Refrigerator



- 1. Water filter
- 2. Door shelf
- 3. Body shelf (adjustable height)
- 4. Water dispenser
- 5. Gallon door shelf (adjustable height)
- 6. Odour filter
- 7. Crisper / Everfresh compartment
- 8. Control display
- 9. Special temperature compartment
- 10. Ice machine
- 11. Barcode label (identification plate)
- 12. Condenser
- 13. Icebox
- 14. Upper drawer
- 15. Lower drawer

May not be available in all models



Figures in this user manual are schematic and may not match the product exactly. If your product does not have the relevant parts, the information applies to other models.

3 Display Appearance

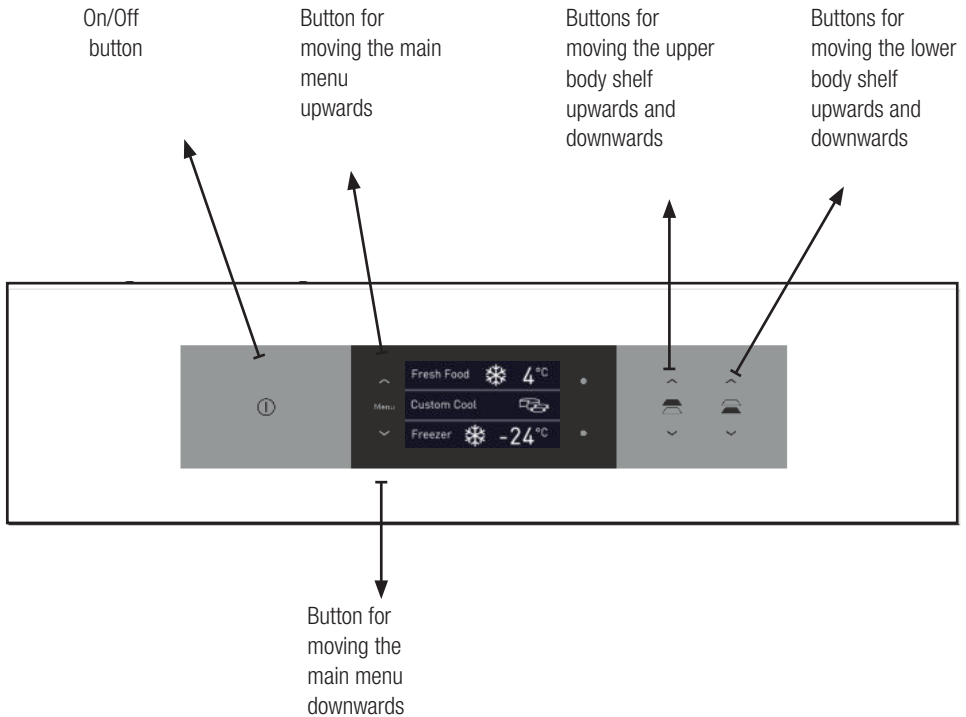

May not be available in all models



Figures in this user manual are schematic and may not match the product exactly. If your product does not have the relevant parts, the information applies to other models.

3.1 On/Off Function



Press the button to switch on the product. The product will be switched on in 10 seconds. Press and hold the on/off button for 3 seconds to switch off.

Just press the on/off button to switch on the product again. The display will turn off in 10 seconds.

3.2 General Display Appearance

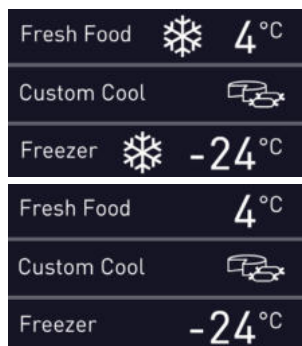

This is the main screen you will see when you open the door of the product. The product consists of 3 main compartments.

- Fresh food compartment.
- Special fridge compartment
- Freezer compartment

You can see the current temperatures of these compartments on the display. The snow symbol on the screen will be displayed during quick cooling/freezing.

3.3 Fresh Food Compartment Setting Function

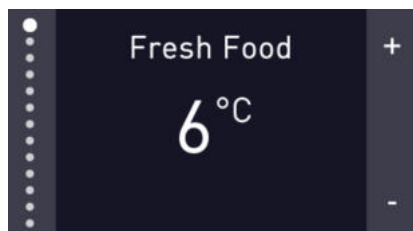

This function allows you to set the temperature of the fresh food cooling compartment.

You can use "+" and "-" keys to set the temperature of the refrigerator to 1, 2, 3, 4, 5, 6, 7, 8°C (33-34-35-36-37-38-39-40-41-42-43-44-45-46°F) respectively.

Note: You must wait for 24 hours for the refrigerator to reach the desired temperature.

3.4 Quick Fridge Function

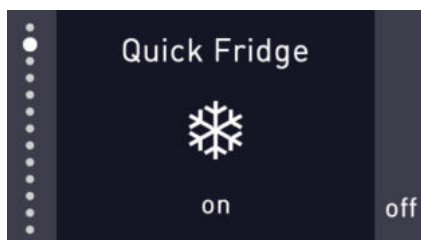

When you press the Quick Fridge button, the temperature of the compartment will be lower than the adjusted values.

You can use this function to rapidly cool the food you've placed in the fridge compartment.

If you want to cool large amounts of fresh food, it is recommended to activate this feature before putting the food into the fridge. When the quick fridge function is enabled, the quick fridge indicator becomes on and the set value is adjusted to 1 °C automatically. A snow symbol will be displayed on the main screen when the quick fridge function is enabled. Press the Off key to deactivate this function. The snow symbol will disappear and the product will return to its previous settings. If you do not deactivate it, the quick fridge function will deactivate itself automatically after 2 hours or when the fridge compartment reaches the required temperature. This function will not be recalled when power restores after a power failure.

3.5 Freezer Compartment Setting Function

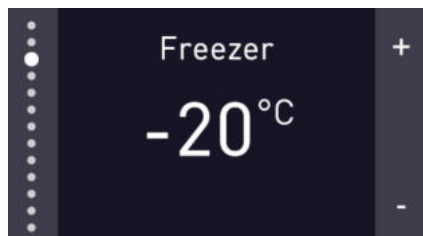

It allows you to set the temperature of the freezer compartment. You can use "+" and "-" keys to set the temperature of the freezer compartment to -18, -19, -20, -21, -22, -23, -24 °C (0, -1, -2, -3, -4, -5, -6, -7, -8, -9, -10, -11, -12°F) respectively.

3.6 Quick Freeze Function

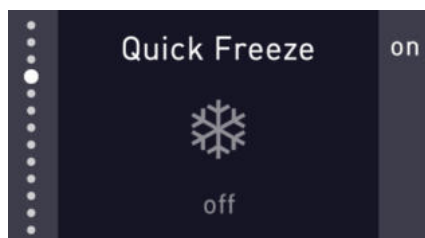

If you want to freeze large amounts of fresh food, press the quick freeze button before putting the food into the freezer compartment.

When the quick freeze function is enabled, the quick freeze indicator becomes and the set value is adjusted to -27°C automatically. Press the Off key to deactivate this function. The quick freeze indicator will go off and the product will return to its normal settings. If you do not cancel it, the quick freeze will cancel itself automatically after 25 hours or when the freezer compartment reaches the required temperature. This function will not be recalled to resume when power restores after a power failure.

3.7 Special Fridge Compartment



Foods can be stored in 4 different modes in this compartment. You can select "Delicatessen", "Vegetable", "Meat" and "Fish" modes from the menu.

Delicatessen: It is the special fridge mode you can use to store your cheese and breakfast food.

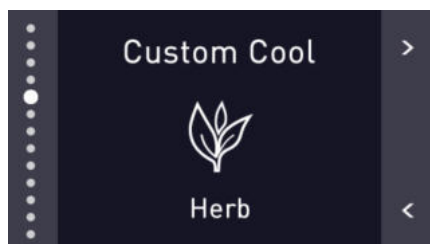

Vegetables: It is the special fridge mode you can use to store your vegetables.

Meat: It is the special fridge mode you can use to store your meat.

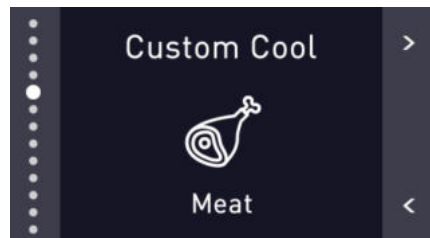

Fish: It is the special fridge mode you can use to store your fish.



3.8 Eco Function

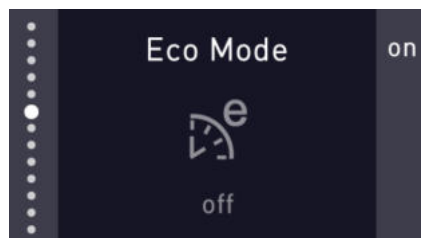

Eco mode is the function you can use to operate your product with less power. It is used to enable/disable the eco mode function. The Eco mode indicator remains on when the Eco mode function is enabled. The refrigerator will start operating in the economy mode at least 6 hours after the Eco mode has been turned "ON".

3.9. Vacation Function

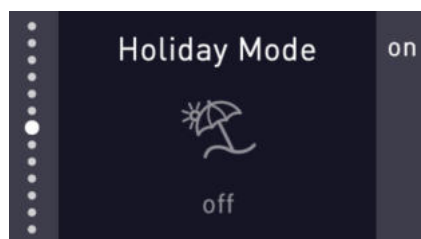

You can enable this mode if you are going on holiday or will not use the product for a long time. Your food in the freezer compartment will keep their cold state and continue to be preserved. Do not place food in the fresh food compartment when this mode is enabled. You can press the on/off key from the Vacation mode menu to enable/disable the Vacation function.

3.10. Ice Machine

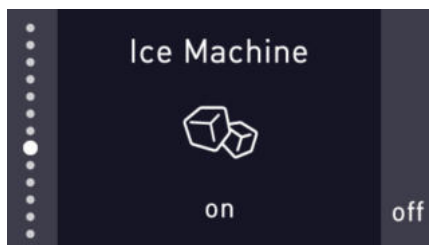

It is the automatic ice machine used to take ice from the product. You can use this menu to turn the ice machine "on" or "off". Ice cubes accumulate in the icebox.

3.11 Water Dispenser

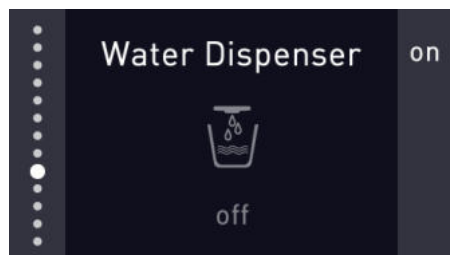

You can use this menu to turn the water dispenser "on" or "off". Push the water dispenser latch with your glass to take water from your refrigerator.

3.12 Child Lock/Key Lock

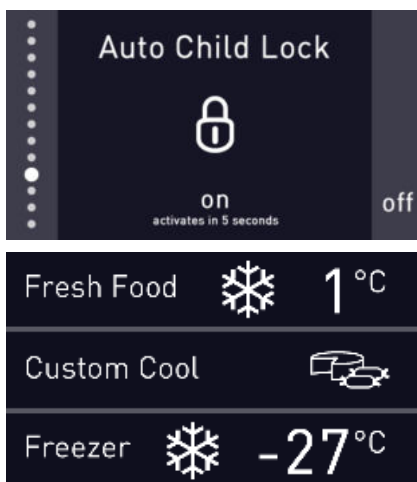

The child lock page is a feature for preventing children from changing the product settings. A lock symbol will appear on the display and the lock will be enabled 5 seconds after you have pressed "on" key on the child lock page. Buttons are inactive when this function is enabled. When you press any key to deactivate the lock, you will see "Cancel child lock?" on the display. You can exit this mode by pressing "Yes".

3.13 Sabbath Mode

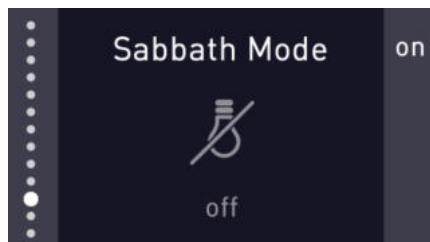

This product has a Sabbath feature. Lights of the refrigerator will not become on, the display will not operate and the door open alarm cannot be activated while the Sabbath mode is active. You can use "On" or "Off" features to activate/deactivate this mode.

3.14 Filter Reset

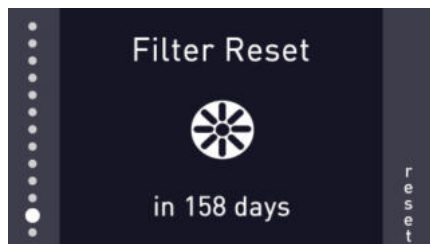

The water filter is used to filter foreign particles in the water and it has a limited service life. This menu is used to track the replacement time of the Water Filter used in the refrigerator. The counter starts when "reset" is selected from this menu after a filter has been installed. You can see the remaining days for the filter to complete its service life. The display gives a warning when the filter needs to be replaced.

NOTE: Change the filter when you see this warning.

Once the filter replacement warning has been displayed, you will see the filter replacement page once a day unless you press reset.

3.15 Temperature Unit Change Screen

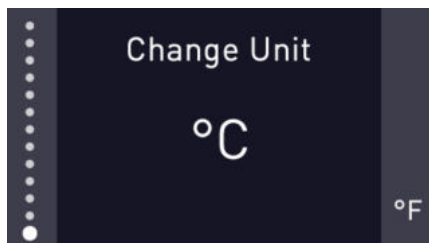

You can set the temperature unit to Centigrade or Fahrenheit from this menu.



There might be a layer if your display keys do not function. In this case, clean with a dry and clean cloth.

4 Preparation

4.1 Things to Do for Energy Saving



Connecting your refrigerator to systems that save energy is dangerous as they may cause damage on the product.

- Do not leave the doors of your refrigerator open for a long time.
- Do not put hot food or drinks in your refrigerator.
- Do not overload the refrigerator. Cooling capacity will fall when the air circulation in the refrigerator is hindered.
- Do not place the refrigerator in places subject to direct sunlight. Install the product at least 30 cm away from heat sources such as hobs, ovens, heater units and stoves and at least 5 cm away from electrical ovens.
- Pay attention to store your food in refrigerator in closed containers.
- You can remove the drawer shelf of the freezer compartment to fill the freezer compartment with maximum amount of food. The given energy consumption value of the refrigerator has been determined with the freezer compartment shelf or the drawer removed and the refrigerator filled with maximum amount of food. There is no harm in using a shelf or drawer according to the shapes and sizes of food to be frozen.
- Thawing the frozen foods in the fridge compartment both saves energy and reserves the quality of the foods.



Temperature of the room where your refrigerator is located should at least be 10°C/50°F. Operating your refrigerator under cooler conditions is not recommended with regard to its efficiency.



Inside of your refrigerator must be cleaned thoroughly.



If two coolers are to be installed side by side, there should be at least 4 cm distance between them.

4.2 Recommendations About the Fresh Food Compartment

- Make sure that the food does not touch the temperature sensor in fresh food compartment. To allow the fresh food compartment to keep its ideal storage temperature, the sensor must not be hindered by food.
- Do not place hot foods or beverages inside the product.

4.3 Initial use

Before using the product, make sure that all preparations have been made in accordance with the instructions given in the "Important instructions regarding safety and environment" and "Installation Instruction" chapters.

- Clean the interior of the refrigerator as recommended in the "Maintenance and cleaning" section. Before you start the refrigerator, make sure that the interior is dry.
- Plug the refrigerator in a grounded socket. The interior illumination is lit when the door of the refrigerator is opened.
- Operate the refrigerator for 6 hours without placing any food in it and do not open its door unless it is necessary.



You will hear a noise when the compressor starts up. The liquids and gases sealed within the refrigeration system may also give rise to noise, even if the compressor is not running and this is quite normal.



Front edges of the refrigerator may feel warm. This is normal. These areas are designed to be warm to avoid condensation.

5 Operating the product

5.1 Dual Cooling System

Your refrigerator is equipped with two separate cooling systems to cool the fresh food compartment and freezer compartment. Thus, the air and odour in the fresh food compartment and the frozen food compartment do not get mixed. Thanks to these two separate cooling systems, cooling speed is much higher than that of other refrigerators. Also additional power saving is provided since the defrosting is performed separately.

5.2 Freezing Fresh Food

- Wrap the foods or place them in a covered container before putting them in the refrigerator.
- Hot foods and beverages must cool down to the room temperature before you put them in the refrigerator.
- The foodstuff that you want to freeze must be fresh and in good quality.
- Divided the food into portions according to your family's daily or meal based consumption needs.
- Pack the foods in an airtight manner to prevent them from drying even if they are going to be stored for a short time.
- Materials to be used for packaging must be tear-proof and resistant to cold, humidity, odor, oils and acids and they must also be airtight. Moreover, they must be well closed and they must be made from easy-to-use materials that are suitable for deep-freezers.
- Frozen food must be used immediately after they are thawed and they should never be re-frozen.
- Do not freeze too large quantities of food at one time. The quality of the food is best preserved when it is frozen right through to the core as quickly as possible.
- Placing warm food into the freezer compartment causes the cooling system to operate continuously until the food is frozen solid.

5.3 Recommendations for Storing Frozen Food

- Frozen foods you purchase must be stored according to the conditions and temperature determined by the food manufacturer.
- Note the following to ensure that the high quality achieved by the frozen food manufacturer and the food retailer is maintained:
 1. Put packages in the freezer as quickly as possible after purchase.
 2. Make sure that the content of the package is labeled and dated.
 3. Check whether the "Use By" or "Best Before" date on the packaging is expired or not.

5.4 Placing the Food

Freezer compartment shelves	Various frozen food such as meat, fish, ice cream, vegetables etc.
Egg tray	Eggs
Fridge compartment shelves	Food in pans, covered plates and closed containers
Door shelves of fridge compartment	Small and packaged foods or beverages (such as milk, fruit juice, beer and etc.)
Crisper	Vegetables and fruits
Special fridge compartment	Delicatessen products (cheese, butter, salami etc.)

Operating the Product

5.5 Information About Deep Freezing

Food must be frozen as rapidly as possible when they are put in a refrigerator in order to keep them in good quality.

You can keep the freshness of food for many months (at -18 °C / 0°F or lower temperatures in the deep freezer).



Divided the food into portions according to your family's daily or meal based consumption needs.



Pack the foods in an airtight manner to prevent them from drying even if they are going to be stored for a short time.



Frozen food must be used immediately after they are thawed and they should never be re-frozen.

Fridge and freezer systems with dual cooling systems have been designed to maintain net, consistent temperature and appropriate humidity levels to meet long food life expectations. The dual cooling system prevents fresh food smells from getting mixed with frozen foods or ice and it does not freeze the humidity in the air within the fresh food compartment.

Materials to be used for packaging the foodstuff must be tear-proof and resistant to cold, humidity, odor, oils and acids.

Foods to be frozen should not be allowed to come in contact with the previously frozen items to prevent them from getting thawed partially.

Freezer Compartment Setting	Fridge Compartment Setting	Remarks
-18°C / 0°F	4°C / 39°F	This is the recommended normal setting.
-20°C / -4°F	3°C / 37°F	These settings are recommended when the ambient temperature is above 30°C/86°F.
Quick Freeze	4°C / 39°F	Use when you wish to freeze your food in a short time. Your refrigerator will return to its previous mode when the process is over.
-24°C / -12°F	2°C / 35°F	Use these settings if you think that your fridge compartment is not cold enough because of the hot ambient conditions or frequent opening and closing of the door.
-18°C / 0°F or colder	Quick Fridge	Use this function when you place too much into the fridge compartment or when you need to cool your food quickly. It is recommended that you activate Quick Fridge function 4-8 hours before placing the food.

Recommended Operating Temperature: Fridge: 4°C / 39°F Freezer: -18°C / 0°F

5.6 Blue Light

(May not be available in all models)

Crispers of the refrigerator are illuminated with a blue light. Foods stored in the crisper continue their photosynthesis by means of the wavelength effect of blue light, and thus they preserve their freshness and increase their vitamin content.

5.7 Ioniser

(May not be available in all models)

Air is ionised by means of the ioniser system in the air duct of the fridge compartment. Thanks to this system, air-borne bacteria and odouring molecules are eliminated.

5.8 Description and Cleaning of the Odour Filter

(May not be available in all models)

The odour filter prevents bad odours on your filter. To clean the odour filter:

1. Pull the cover on which the odour filter is installed towards yourself from the front section and remove it.

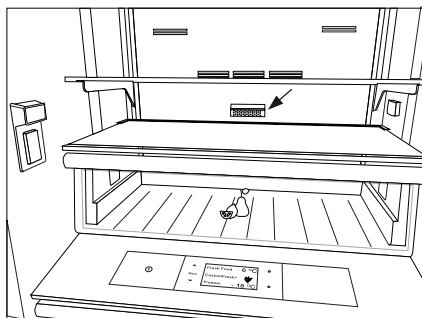

2. Leave the filter under sunlight for 12 hours. The filter will be cleaned during this period.
3. Install the filter back into its place.



Odor filter must be cleaned once a year.

5.9 Door Open Warning

(May not be available in all models)

An audible warning will be heard if the door of the product remains open for 1 minute. You can silence this audible warning by pressing any key on the control panel or closing the door.

5.10 Interior Lighting

A LED-type lamp is used for interior lighting. Please consult the authorised service provider about any problem with this lamp.

Lamp/lamps used in this product is/are not suitable for house/room lighting. The intended purpose of this lamp is to help the user place foods into the fridge/freezer safely and easily.

5.11 Sabbath Mode:

(May not be available in all models)

This mode has been designed for short-term use. Lighting means, the display and the door open alarm will be disabled when the Sabbath mode is active. With this mode, a stable cooling performance is aimed when storing meals and vegetables. For this reason, it is not recommended to use this mode when the product is being used often or has just been loaded. The Sabbath mode is activated by pressing the "ON" key on the Sabbath screen under the menu and it is displayed on the screen. Door buttons can be locked and unlocked with the mechanical switch when desired. You need to press the "OFF" key on the menu to deactivate the Sabbath mode.

For low ambient temperatures (lower than 10°C), it is recommended to set the refrigerator temperatures to -18/ 6 °C before activating the Sabbath mode.

For high ambient temperatures (higher than 35°C), it is recommended to set the refrigerator temperatures to -24/ 2 °C before activating the Sabbath mode.

Leaving the product in the Sabbath mode for a long time may cause the foods to spoil at high temperatures.

5.12 Vacation Function

To activate this function, disconnect the power from the control panel. Empty the unit and fix the doors so that they remain ajar to let fresh air enter the unit and keep the interior of the unit dry. Select and activate the vacation mode from the control display of your product.

5.13 Water Filter

The water filter is used to filter foreign particles in the water and it has a limited service life. The water filter does not filter out the microorganisms in the water.

Your product is equipped with an internal water filter to be used within the refrigerator. Part number of the filter is 4874960100. You can use this part number when ordering filter for replacement.

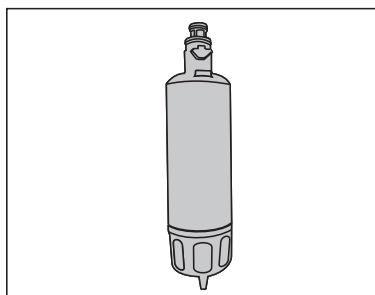

Service life of the water filter is 6 months.

5.14 Water connection

(May not be available in all models)

Your refrigerator may be equipped with an external or internal filter. Look at the figures below and follow the instructions to install the water filter:



Please see the installation instruction to connect the product to the mains.

5.15 Attaching/Removing the Internal Filter to/from the Refrigerator

First of all, turn "OFF" the ice machine and water dispenser from the control display of the product.

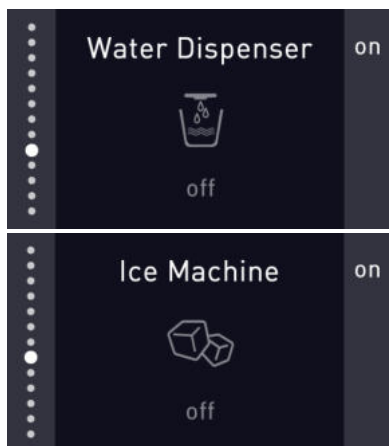

To install the filter to the product:

1. Slightly press the front side of the water filter lid, which is located at the top-left corner of the fresh food compartment, to open it.
2. As seen in the figure, push the water filter into its slot in an angled position. Then keep the filter in a horizontal position and press on the lid to close it.

To remove the filter from the product:

1. Slightly press the front side of the water filter lid, which is located at the top-left corner of the fresh food compartment, to open it.
2. Keep the water filter in a downwards angled position, pull it towards yourself and remove it.



It is normal that a few drops of water drip after the water filter has been removed.

3. Slightly push the water filter lid upwards to close it.
4. Select the "ON" mode to exit this mode.

If you want to use the ice machine and the water dispenser without the water filter, install the by-pass cover the same way you install the water filter.



The water dispenser or ice machine can never be used without the water filter or by-pass cover installed. Otherwise, water will come out from that part.

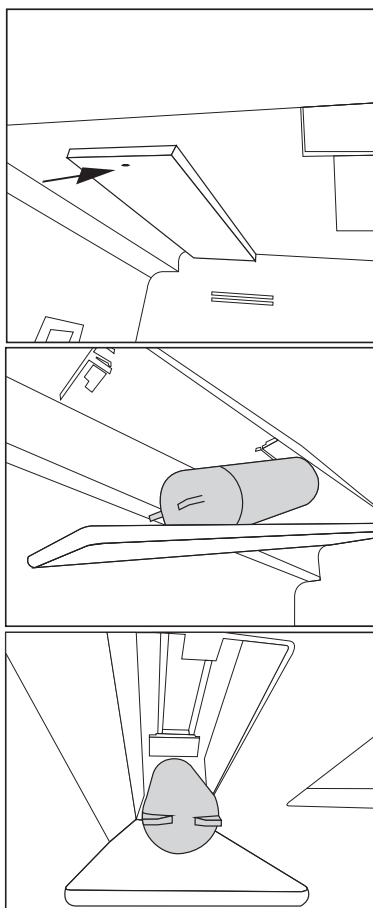



All air must be discharged from the system and the filter must help with cleaning the water lines when the water filtering system is being used for the first time or after replacing the filter. For models with a water dispenser, drain 15 liters (4 gallons) of water. If you are not going to use the water filtering system, you can remove the filter and switch the water filter to by-pass mode.

5.16 Using the Internal Water Dispenser

(May not be available in all models)

After connecting the refrigerator to the water supply or replacing the water filter, press and hold the water dispenser latch for 5 seconds and use a durable container to clean the water system. Then release the latch for 5 seconds, and keep performing these procedures until water flows. When the water starts to flow, repeat the same steps until you discharge 15 liters of water. This procedure will discharge the air in the filter and water dispenser to make the water system ready to use. Water may rush from the dispenser when air comes from the system.

It will take the water 24 hours to cool down to the temperature of the refrigerator after draining large amounts of water and during the first filling process.



The water dispenser will stop dispensing to prevent flooding after the user has taken water continuously for 60 seconds. Press the dispenser latch again to continue taking water.



Please call the authorised service if you see water leakage on the product after it has been connected to the water supply.



It is normal that a few drops of water drop from the dispenser after you have taken water.

5.17 Water Dispensing

Press the water dispenser latch and hold a vessel under it at the same time.

Release the dispenser latch to stop dispensing water.



It is normal for the first few glasses of water taken from the dispenser to be warm after the product has just been connected to the water supply.



If the water dispenser has not been used for a long time or if it is going to be used for the first time, dispose of the first 6 glasses of water to get clean water.

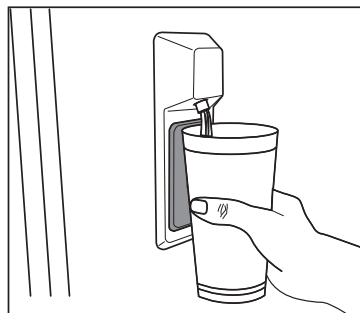

5.18 Before Using the Water/Ice Dispenser

- A separate water pump must be used if the water pressure is lower than 1 bar or if a demijohn is going to be used.
- Water system of the refrigerator must be connected to the cold water line. **It must not be connected to the hot water line.**
- The water pressure must be between 1-5.5 bars for the water dispenser to operate smoothly.
- You must wait for 12 hours approximately to get ice from the ice machine. If the ice in the icebox is not sufficient, the ice machine might not dispense ice cubes.



Do not use the water dispenser before reading and confirming "1.1.2 For products with a water dispenser" on page 5.

5.19 Icebox

The icebox is used to collect ice cubes coming from the ice machine. Do not pour water into the box to make ice. Otherwise, it may break. The icebox cannot be used to store foods.

To remove the icebox, pull the freezer drawer completely and take out the icebox. To install it again, take out the drawer carrier and align the bottom of the box with the carrier. Please see the figure below.

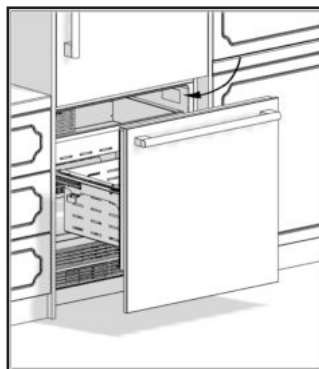

Ice cubes may stick to each other if not used for 5 days. For this reason, you can crush the ice cubes using the ice cube scoop provided with the appliance.

The ice machine must be turned off from the control display when the ice storage container is removed.

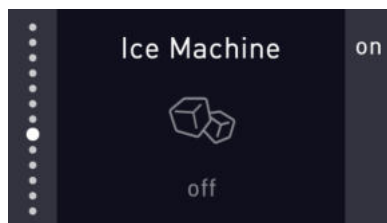

5.20 Door Shelves

To remove a door shelf, hold the shelf from the lower section, lift it and slide it outwards. Please see the figure.

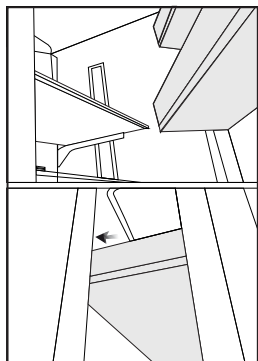

If opening the door is limited with 90°, you may have to remove the door shelves before removing a storage drawer or glass shelf.

5.21 Adjustable Door Shelf

(May not be available in all models)

Press and hold the buttons at the right and left-hand sides to adjust the door shelf to the desired position without having to remove it. To remove the adjustable door shelf, press and hold the buttons, lift the shelf completely and pull it towards yourself. To install the door shelf back, put it into its place on the door and slide it downwards by pressing the buttons. Please see the figure.

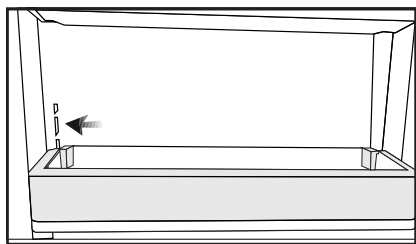

5.22 Glass Shelves

(May not be available in all models)

Height of the glass shelves on your product can be adjusted manually or with rear hangers.

Please follow the instructions below to remove, install and adjust a glass shelf.



ATTENTION:

Glass shelves must be unloaded.

1. Hold the shelves with rear hangers as shown below. Your hands must be at the rear section. Make sure you are holding the shelf tightly from the bottom.

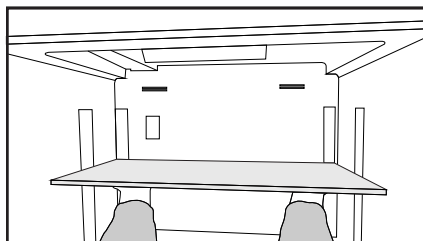

2. Lift the front section of the glass shelf as shown below and bring it to an angled position.

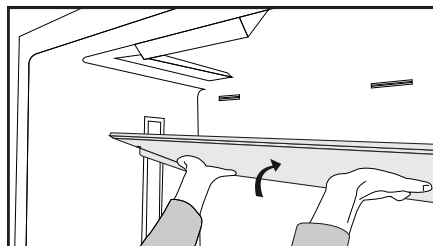

3. Once it is angled, tabs on the hangers will be released and the glass shelf will move up and down. Thus you can adjust the position.
4. To remove the glass shelf, bring it to the maximum height and pull towards yourself.
5. To install the glass shelf, place the pins at the rear corner of the shelf into the slots through the gap at the top and slide it downwards in an angled manner.

Operating the Product



ATTENTION:

You must wait for the glass shelves to reach room temperature before immersing them in water for cleaning.



ATTENTION:

The door may not be closed if the door shelves are positioned at the same level as glass shelves. Make sure that the door is closed after placing the shelves.

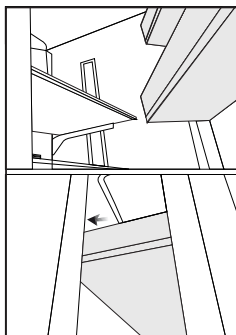

5.23 Motor Glass Shelves

(May not be available in all models)

Having rear hangers, the electronic glass shelves are adjusted with the buttons at the left side of the control display through a motor. You can use these buttons to move it up and down.



ATTENTION:

Since the glass shelves are controlled electronically, please do not attempt to adjust them manually.



ATTENTION:

The electronic shelf can bear 45 kg maximum while moving.

5.24 Humidity-Controlled Crisper

(Crisper Compartment)

(May not be available in all models)

Thanks to its humidity control feature, it keeps the humidity rates of fruits and vegetables at a certain level and keeps foods fresh for a longer period.

To remove the crisper:

1. Pull the crisper until it stops.
2. Slightly lift the front section of the drawer and take it out completely.

To install the crisper:

1. Pull the rails completely.

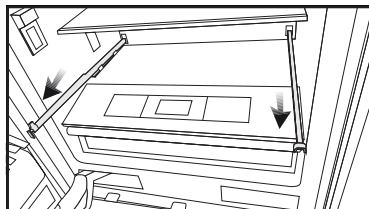

2. Place the gap at the rear corners of the crisper to the detail located at the rear corners of the rails.

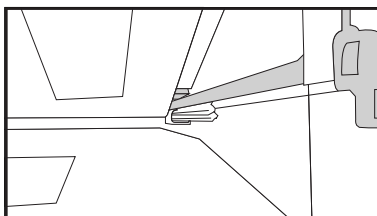

3. Place the detail at the front section of the rail to the gap at the front part of the crisper.

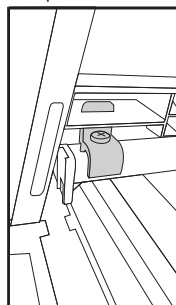

Operating the Product



Make sure that the details at the right and left-hand sides are fixed when installing the crisper.



Never leave the vegetables in their plastic bags in the crisper. If they are left in their plastic bags they will rot in a short period of time.

The humidity-controlled crisper feature preserves the humidity of your vegetables, allowing you to store them for a long time without having to keep them in their bags. If you do not prefer the vegetables to get into contact with other vegetables due to hygienic reasons, you can use perforated paper, foam or a similar material instead of plastic bags.

While the vegetables are being replaced, their specific weights should be taken into consideration. Heavy and hard vegetables must be placed at the bottom of the crisper and light and soft vegetables must be on the upper part. Pears, kiwis, tomatoes, cucumbers, apricots, peaches, broccolis, lettuces, cabbages, parsley and spinach are fruits and vegetables that emit ethylene gas. Do not place them into the same crisper with other fruits and vegetables. The ethylene gas emitted by these foods cause other fruits and vegetables to ripen sooner and to rot in a shorter span of time.

Do not remove the main body of the crisper from the refrigerator separately unless you have to do so.



ATTENTION:

If there is a blue light on the refrigerator, do not look at the blue light with optical tools.

5.25 Special Fridge Compartment

You can control the temperature in this section to store your food such as fish, meat, vegetables and delicatessen products for a long time. To do so, select the type of the food you want to store from the display of the refrigerator and place your food into the special fridge compartment.



Removal/installation procedures of the special fridge compartment are same as that of the humidity-controlled crisper.

5.26 Freezer Drawers

The freezer compartment store your foods at a temperature between -24°C and -18°C to keep them fresh for a long time.

To Remove the Freezer Crisper:

1. Pull the crisper until it stops.
2. Slightly lift the front section of the drawer and take it out completely.

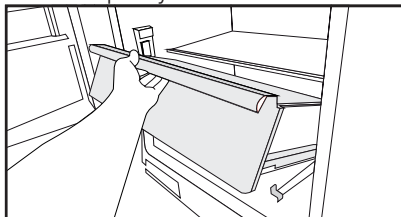

To Install the Freezer Crisper:

1. Pull the rails completely.

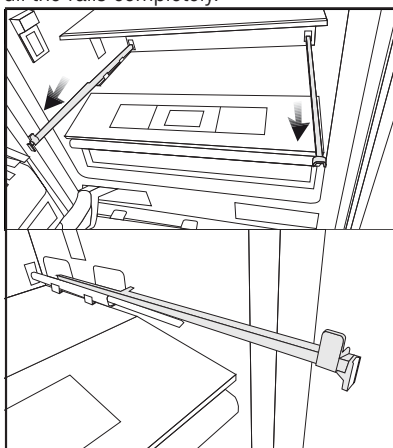

Operating the Product

2. Place the gap at the rear corners of the crisper to the detail located at the rear section of the rails.

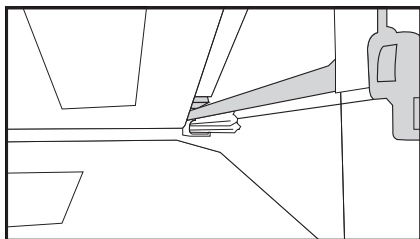

3. Place the detail at the front section of the rail to the gap at the front part of the crisper.

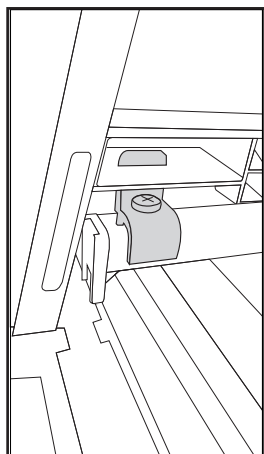

5.27 Hinge Adjustment

When adjusting the hardness of the hinge:

- Hardness of the lower and upper door hinges of the fresh food compartment is performed with the help of a drill. Set the hinge adjustment screw to position "1" from position "0".



ATTENTION:



This adjustment must be made after the door has been installed and opened completely.

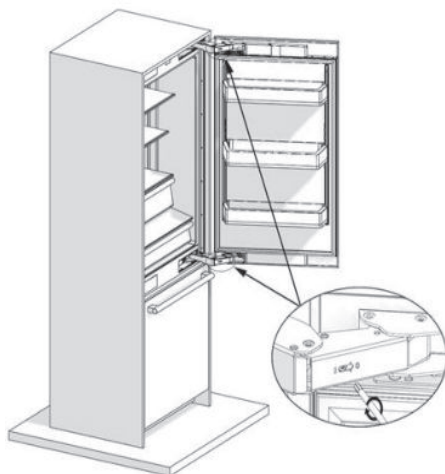

5.28 Changing the Direction of the Door

Please see the installation instructions provided in the bag.

6 Care and cleaning

Service life of the product will extend and frequently encountered problems will decrease if the product is cleaned periodically.



WARNING: Switch off the product before cleaning.



WARNING: It is recommended to clean the condenser every six months using gloves. You must not use vacuum cleaners.

- Never use gasoline, benzene or similar substances for cleaning purposes.
- Never use any sharp abrasive instruments, soap, household cleaners, detergent or wax polish for cleaning.
- Dissolve one teaspoon of carbonate in half liter of water. Soak a cloth in the solution and wring it thoroughly. Wipe the interior of the refrigerator with this cloth and the dry thoroughly.
- Make sure that no water enters the lamp housing or other electrical parts.
- If you will not use the refrigerator for a long time, unplug it, remove all food inside, clean it and leave the door ajar.
- Check regularly that the door gaskets are clean. If not, clean them.
- Take out all items in the product to remove the door and body shelves.

- Remove the door shelves by pulling them up. Slide the shelves downwards to re-install them after cleaning.
- Never use chloric cleaning agents or water to clean outer surfaces or chrome-coated parts of the product. Chlorine causes abrasion on such metal surfaces.

6.1. Avoiding Bad Odours

Materials that may cause odour are not used in the production of our refrigerators. However, odour may be emitted if foods are stored improperly or if the inner surface of the product is not cleaned as required. Please consider the following to avoid this problem:

- It is important that the refrigerator is kept clean. Food residuals, stains, etc. can cause odour. For this reason, clean your refrigerator with carbonate solved in water every 15 days. Never use detergents or soap.
- Keep your foods in closed vessels. Microorganisms emitted from vessels without a cover may cause unpleasant odours.
- Never keep expired or spoiled foods in your refrigerator.

6.2. Protecting the Plastic Surfaces

Do not put liquid oils or oil-cooked meals in your refrigerator in unsealed containers as they damage the plastic surfaces of your refrigerator. If oil is spilled or smeared onto the plastic surfaces, clean and rinse the relevant part of the surface with warm water immediately.

6.3 Cleaning the Inner Surface

To clean the inner surfaces and all removable parts, wash them with a mild solution comprising soap, water and carbonate. Rinse and dry thoroughly. Prevent the water from contacting the lighting means and control panel.



ATTENTION:

Do not use vinegar, rubbing alcohol or other alcohol-based cleaning agents on any of the inner surfaces.

6.4 Stainless Steel Outer Surfaces

Use a stainless steel cleaning agent that is non-abrasive and apply it with a lint-free, soft cloth. For polishing, wipe the surface softly with a damp microfiber cloth and use dry wash-leather. Always follow the strands of the stainless steel.

7 Troubleshooting

Please review this list before calling the service. This will save you time and money. This list contains frequently encountered problems that are not results of faulty workmanship or material use. Your product may not have some of the features described here.

The refrigerator is not operating.

- It may not be plugged in properly. >>>Plug in the product properly.
- The fuse of the socket to which your refrigerator is connected or the main fuse may have blown. >>>Check the fuse.

Condensation on the side wall of the fridge compartment (MULTI ZONE, COOL CONTROL and FLEXI ZONE).

- The door may have been opened/closed frequently. >>>Do not open/close the refrigerator door frequently.
- The environment may be too humid. >>>Do not install the refrigerator at locations with a very high level of humidity.
- Foods containing liquid may have been placed into the refrigerator in vessels without covers. >>>Do not place foods containing liquid into the refrigerator in unsealed vessels.
- Door of the refrigerator may have been left ajar. >>>Do not keep the doors of your refrigerator open for a long time.
- The thermostat may have been set to a very cold level. >>>Set the thermostat to an appropriate level.

The compressor is not operating.

- Protective thermal of the compressor will blow out during sudden power failures or plug-out plug-ins as the refrigerant pressure in the cooling system of the refrigerator has not been balanced yet. The refrigerator will start running approximately after 6 minutes. Please call the Authorised Service Provider if the refrigerator does not start at the end of this period.
- The freezer is in defrosting cycle. >>>This is normal for a refrigerator that performs full-automatic defrosting. Defrosting cycle is performed periodically.
- The refrigerator may not be plugged in. >>>Make sure that the plug fits the socket.
- Temperature settings may be incorrect. >>>Select the correct temperature value.
- Possible power failure. >>>The refrigerator will start to operate normally when power restores.

The operation noise increases when the refrigerator is running.

- Operating performance of the refrigerator may vary based on the ambient temperature changes. This is normal and not a fault.

Troubleshooting

The fridge is running frequently or for a long time.

- Your new product may be bigger than the previous one. Larger refrigerators operate for a longer period of time.
- The room temperature may be high. >>> It is normal that the product operates for longer periods in hot environments.
- The refrigerator may have just been plugged in or loaded with food. >>>It takes the product longer to reach the set temperature when it has just been plugged in or loaded with food. This is normal.
- Large amounts of hot food may have been placed into the refrigerator recently. >>>Do not place hot foods into the refrigerator.
- The doors may have been opened frequently or left ajar for a long time. >>>The warm air that enters the refrigerator causes it to operate for a longer period of time. Do not open the doors frequently.
- Freezer or fridge compartment door may have been left ajar. >>> Check if the doors are closed completely.
- The appliance may be set to a very low temperature. >>> Set the refrigerator temperature to a warmer degree and wait until the product reaches this temperature.
- Door seal of the fridge or freezer compartment may be soiled, worn out, broken or not properly seated. >>> Clean or replace the seal. Damaged/broken seal causes the refrigerator to run for a longer period of time to maintain the current temperature.

Fridge temperature is adequate but the freezer temperature is very low.

- The freezer compartment temperature may be set to a very low value. >>> Set the freezer compartment temperature to a higher value and check.

Freezer temperature is adequate but the fridge temperature is very low.

- The fridge compartment temperature may be set to a very low value. >>> Set the fridge compartment temperature to a higher value and check.

Food kept in the fridge compartment drawers is frozen.

- The fridge compartment temperature may be set to a very high value. >>> Set the fridge compartment temperature to a lower value and check.

Temperature in the fridge or freezer is very high.

- The fridge compartment temperature may be set to a very high value. >>> Fridge compartment temperature setting has an effect on the temperature of the freezer. Change the temperature of the fridge or freezer compartment until the fridge or freezer compartment temperature reaches an adequate level.
- The doors may have been opened frequently or left ajar for a long time. >>>Do not open the doors frequently.
- The door may have been left ajar. >>>Close the door completely.
- The refrigerator may have been just plugged in or loaded with food. >>>This is normal. It takes the product longer to reach the set temperature when it has just been plugged in or loaded with food.
- Large amounts of hot food may have been placed into the refrigerator recently. >>>Do not place hot foods into the refrigerator.

Troubleshooting

Vibration or noise.

- The floor may not be stable or level. >>>If the refrigerator shakes when moved slightly, adjust the feet to balance it. Make sure that the floor is level and capable of carrying the refrigerator.
- Objects placed onto the refrigerator may cause noise. >>>Remove the objects on the refrigerator.

There are noises coming from the refrigerator like liquid spilling or spraying.

- Liquid and gas flows occur in accordance with the operating principles of the refrigerator. >>>This is normal and not a fault.

Whistle is heard from the refrigerator.

- There are fans that are used to cool the refrigerator. This is normal and not a fault.

Damp accumulates on the inner walls of refrigerator.

- Hot and humid weather increases icing and condensation. This is normal and not a fault.
- The doors may have been opened frequently or left ajar for a long time. >>>Do not open the doors frequently. Close the doors, if open.
- The door may have been left ajar. >>>Close the door completely.

Humidity occurs on the outer surface of the refrigerator or between the doors.

- Air might be humid. This is quite normal in humid weathers. >>>Condensation will disappear when the humidity level decreases.
- There might be external condensation at the section between two doors of the refrigerator if you use your product rarely. This is normal. Condensation will disappear upon frequent use.

There is a bad odour inside the refrigerator.

- No regular cleaning may have been performed. >>>Clean the inside of the refrigerator with a sponge, lukewarm water or carbonated water.
- Some vessels or packaging materials may cause the odour. >>>Use another vessel, or packaging materials from another brand.
- Foods may have been placed into the refrigerator in vessels without covers. >>>Store the foods in closed vessels. Microorganisms emitted from vessels without a cover may cause unpleasant odours.
- Take out expired or spoiled foods from the refrigerator.

The door cannot be closed.

- Food packages may be preventing the door from closing. >>> Re-locate the packages that are obstructing the door.
- The refrigerator may be unstable on the floor. >>>Adjust the refrigerator feet as required to keep the refrigerator in balance.
- The floor may not be level or solid. >>>Make sure that the floor is level and capable of carrying the refrigerator.

Crispers are stuck.

- Foods may be touching the upper wall of the crisper. >>>Re-organise the foods in the crisper.



WARNING: If you cannot eliminate the problem although you follow the instructions in this section, consult your dealer or the Authorised Service Provider. Never attempt to repair a malfunctioned product.

WARRANTY STATEMENT FOR THE BLOMBERG REFRIGERATORS

The warranties provided by Blomberg in these statements only apply to Blomberg refrigerators sold to the original purchaser or homeowner in the US and Canada. The warranty is not transferable. To obtain warranty service, please contact our nearest distributor as listed by state and province. You will need your refrigerator model number, serial number, retailer name and address, where purchased and purchase date / installation date. This warranty gives you specific legal rights, and you may also have other rights which vary from state to state. Also, please make sure you register your product for warranty at www.blombergappliances.com.

1 year (*) full warranty from date of first installation

Blomberg will repair or replace at no cost to the consumer any defective parts of the refrigerator if used under normal household conditions

(warranty is void if the product is used commercially e.g., bed + breakfast, nursing home etc.). Service must also be performed by an authorized Blomberg service agency. (Cosmetic defects must be reported within 10 business days from installation). 1 year warranty on the accessories is for the parts only and does not include labor.

2 year*++ limited warranty from date of first installation (Parts only) Blomberg will repair or replace any parts at no cost to the consumer if material defects or workmanship have caused the damage or failure of these components. Again the refrigerator must have been used under normal household conditions and not commercially as stated above (Labor charges are the responsibility of the consumer).

2-5 year (*, **) limited warranty from date of first installation

(parts only 2-5 years) Blomberg will repair or replace any compressors, evaporators, condensers and dryers at no cost to the consumer if material defects or workmanship have caused the damage or failure of these components.

The refrigerator must have been used under normal household conditions and not commercially (Labor charges are the responsibility of the consumer)

Disclaimers of warranties and exclusions:

Warranty does not cover service costs by an authorized service agent to correct installation, electrical problems or educational instruction on the use of the refrigerator. The warranty also does not cover defects or damage caused by an act of God (such as storms, floods, fires, mudslides, etc.), damage cause by use of the refrigerator for purposes other than those for which it was designed, misuse, abuse, accident, alteration, improper installation, maintenance, travel fees, service calls outside normal service hours, pick up and delivery, any food loss due to product failure, unauthorized service work or work.

This product is fully tested and went through official quality assurance inspections before leaving the original manufacturing site. Warranty terms for this Blomberg household appliance is not valid if the product is altered, tampered, modified, additional parts assembled, fixed and re-packed by an authorized distributor, servicer, a third party retailer, reseller or by any other unauthorized person(s).

TO THE EXTENT PERMITTED BY LAW, THIS WARRANTY IS IN LIEU OF ALL OTHER EXPRESSED AND IMPLIED WARRANTIES, INCLUDING THE IMPLIED WARRANTIES OF MERCHANTABILITY AND FITNESS FOR A PARTICULAR PURPOSE. BLOMBERG UNDERTAKES NO RESPONSIBILITY FOR THE QUALITY OF THIS PRODUCT EXCEPT AS OTHERWISE PROVIDED IN THIS WARRANTY STATEMENT. BLOMBERG ASSUMES NO RESPONSIBILITY THAT THE PRODUCT WILL BE FIT FOR ANY PARTICULAR PURPOSE FOR WHICH YOU MAY BE BUYING THIS PRODUCT, EXCEPT AS OTHERWISE PROVIDED IN THIS WARRANTY STATEMENT.

Blomberg does not assume any responsibility for incidental or consequential damages. Such damages include, but are not limited to, loss of profits, loss of savings or revenue, loss of use of the refrigerator or any associated equipment, cost of capital, cost of any substitute equipment, facilities or services, downtime, the claims of third parties, and injury to property. Some states do not allow the exclusion or limitation of incidental or consequential damages, so the above limitations or exclusion may not apply to you.

(*) Installation date shall refer to either purchase date or 5 business days after delivery of the product to the home, whichever is later.

() Parts replaced will assume the identity of the original parts + their original warranty.**

No Other Warranties. This Warranty Statement is the complete and exclusive warranty from the manufacturer. No employee of Blomberg or any other party is authorized to make any warranty statements in addition to those made in this Warranty Statement.

Please keep this warranty card, user manual and your sales slip for future reference.

HOW TO GET SERVICE

Please contact the Distributor for your State or Province as listed on the Distributor Contact List, or call our Toll Free Number at 1 800 459 9848 for direction to an Authorized Blomberg Service Agent.

Blomberg[®]

seit 1883

www.blomberginternational.com

info@blomberginternational.com