

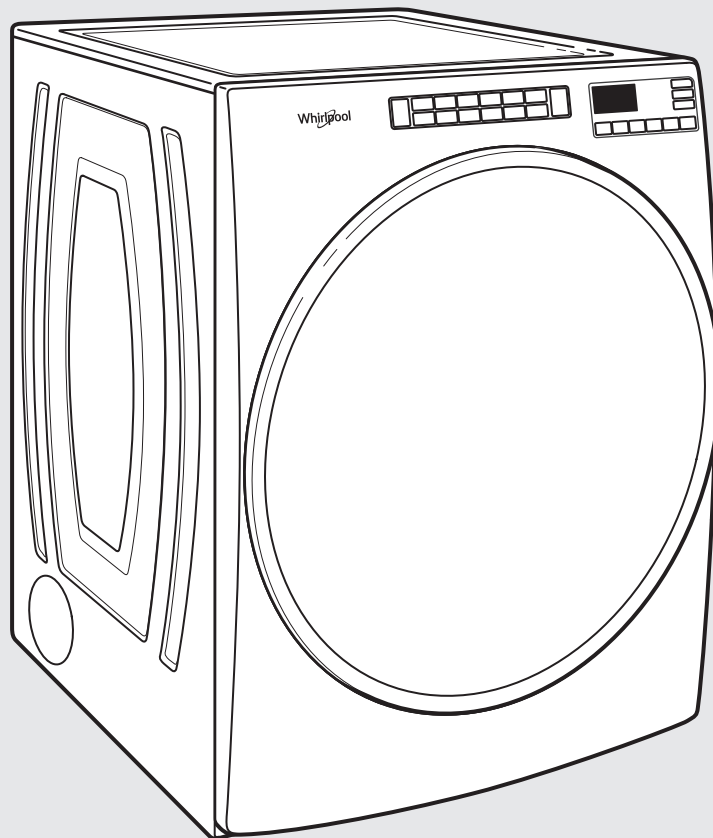

Use and Care Guide Guide d'utilisation et d'entretien

Electronic Dryer Sécheuse électronique



Para obtener acceso
al Manual de uso y
cuidado en español, o para
obtener información adicional
acerca de su producto, visite
www.whirlpool.com.

If you have any problems or questions, visit us at www.whirlpool.com.
Pour tout problème ou question, consulter www.whirlpool.ca.



W11184586A
W11184906A - SP

Table of Contents

DRYER SAFETY	2
ACCESSORIES	4
CHECK YOUR VENT SYSTEM FOR GOOD AIRFLOW.....	5
CONTROL PANEL AND FEATURES.....	6
CYCLE GUIDE.....	8
USING YOUR DRYER	10
ADDITIONAL FEATURES.....	12
DRYER CARE	13
TROUBLESHOOTING	15
WARRANTY	18
ASSISTANCE OR SERVICE.....	Back Cover

Table des matières

SÉCURITÉ DE LA SÈCHEUSE	19
ACCESSOIRES	21
VÉRIFICATION D'UNE CIRCULATION D'AIR ADÉQUATE POUR LE SYSTÈME D'ÉVACUATION	22
TABLEAU DE COMMANDE ET CARACTÉRISTIQUES	23
GUIDE DES PROGRAMMES.....	26
UTILISATION DE LA SÈCHEUSE	28
ENTRETIEN DE LA SÈCHEUSE	31
DÉPANNAGE	33
GARANTIE	38
ASSISTANCE OU SERVICE.....	Couverture arrière

DRYER SAFETY

Your safety and the safety of others are very important.

We have provided many important safety messages in this manual and on your appliance. Always read and obey all safety messages.



This is the safety alert symbol.

This symbol alerts you to potential hazards that can kill or hurt you and others.

All safety messages will follow the safety alert symbol and either the word "DANGER" or "WARNING."

These words mean:

⚠ DANGER

You can be killed or seriously injured if you don't immediately follow instructions.

⚠ WARNING

You can be killed or seriously injured if you don't follow instructions.

All safety messages will tell you what the potential hazard is, tell you how to reduce the chance of injury, and tell you what can happen if the instructions are not followed.



WARNING - "Risk of Fire"

- Clothes dryer installation must be performed by a qualified installer.
- Install the clothes dryer according to the manufacturer's instructions and local codes.
- Do not install a clothes dryer with flexible plastic venting materials or flexible metal (foil type) duct. If flexible metal duct is installed, it must be of a specific type identified by the appliance manufacturer as suitable for use with clothes dryers. Flexible venting materials are known to collapse, be easily crushed, and trap lint. These conditions will obstruct clothes dryer airflow and increase the risk of fire.
- To reduce the risk of severe injury or death, follow all installation instructions.
- Save these instructions.

IMPORTANT SAFETY INSTRUCTIONS

When discarding or storing your old clothes dryer, remove the door.

SAVE THESE INSTRUCTIONS

IMPORTANT SAFETY INSTRUCTIONS

WARNING: To reduce the risk of fire, electric shock, or injury to persons when using the dryer, follow basic precautions, including the following:

- Read all instructions before using the dryer.
- Do not place items exposed to cooking oils in your dryer. Items contaminated with cooking oils may contribute to a chemical reaction that could cause a load to catch fire. To reduce the risk of fire due to contaminated loads, the final part of a tumble dryer cycle occurs without heat (cool down period). Avoid stopping a tumble dryer before the end of the drying cycle unless all items are quickly removed and spread out so that the heat is dissipated.
- Do not dry articles that have been previously cleaned in, washed in, soaked in, or spotted with gasoline, dry-cleaning solvents, or other flammable or explosive substances as they give off vapors that could ignite or explode.
- Do not allow children to play on or in the dryer. Close supervision of children is necessary when the dryer is used near children.
- Before the dryer is removed from service or discarded, remove the door to the drying compartment.
- Do not reach into the dryer if the drum is moving.
- Do not install or store the dryer where it will be exposed to the weather.
- Do not tamper with controls.
- Do not repair or replace any part of the dryer or attempt any servicing unless specifically recommended in this Use and Care Guide or in published user-repair instructions that you understand and have the skills to carry out.
- Do not use fabric softeners or products to eliminate static unless recommended by the manufacturer of the fabric softener or product.
- Do not use heat to dry articles containing foam rubber or similarly textured rubber-like materials.
- Clean lint screen before or after each load.
- Keep area around the exhaust opening and adjacent surrounding areas free from the accumulation of lint, dust, and dirt.
- The interior of the dryer and exhaust vent should be cleaned periodically by qualified service personnel.
- See “Electrical Requirements” located in the installation instructions for grounding instructions.

SAVE THESE INSTRUCTIONS

WARNING:

FIRE OR EXPLOSION HAZARD

Failure to follow safety warnings exactly could result in serious injury, death, or property damage.

- **Do not store or use gasoline or other flammable vapors and liquids in the vicinity of this or any other appliance.**
- **WHAT TO DO IF YOU SMELL GAS:**
 - **Do not try to light any appliance.**
 - **Do not touch any electrical switch; do not use any phone in your building.**
 - **Clear the room, building, or area of all occupants.**
 - **Immediately call your gas supplier from a neighbor’s phone. Follow the gas supplier’s instructions.**
 - **If you cannot reach your gas supplier, call the fire department.**
- **Installation and service must be performed by a qualified installer, service agency, or the gas supplier.**

WARNING: Gas leaks cannot always be detected by smell.

Gas suppliers recommend that you use a gas detector approved by UL or CSA.

For more information, contact your gas supplier.

If a gas leak is detected, follow the “What to do if you smell gas” instructions.

ACCESSORIES

INSTALLATION & MAINTENANCE ACCESSORIES

FACTORY CERTIFIED PARTS – these three words represent quality parts and accessories designed specifically for your appliance. Time tested engineering that meets our strict quality specifications.

FACTORY CERTIFIED PARTS

Accessories designed for your appliance:

Customize your new washer and dryer with the following genuine Whirlpool accessories. For more information on options and ordering, call **1-866-698-2538** or visit us at: www.whirlpool.com/accessories. In Canada, call **1-800-688-2002** or visit us at www.whirlpoolparts.ca.

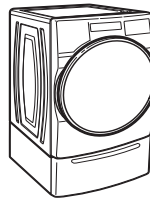

15" Pedestal

Color-matched pedestals raise the washer and dryer to a more comfortable working height. The large drawer provides convenient storage.

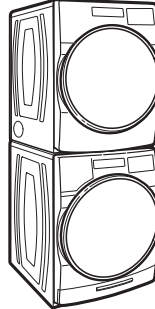

Stack Kit

If space is at a premium, the stack kit allows the dryer to be installed on top of the washer.

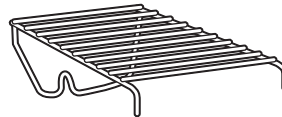

Drying Rack

The Drying Rack provides a stationary drying surface for items such as sweaters and tennis shoes. See the “Additional features” section for more information.

CHECK YOUR VENT SYSTEM FOR GOOD AIRFLOW

⚠ WARNING



Fire Hazard

Use a heavy metal vent.

Do not use a plastic vent.

Do not use a metal foil vent.

Failure to follow these instructions can result in death or fire.

Good airflow

Along with heat, dryers require good airflow to efficiently dry laundry. Proper venting will reduce your drying times and improve your energy savings. See the Installation Instructions.

The venting system attached to the dryer plays a big role in good airflow. Blocked or crushed vents as well as improper venting installation will reduce airflow and dryer performance.

Service calls caused by improper venting are not covered by the warranty and will be paid by the customer, regardless of who installed the dryer. To clean or repair venting, contact a venting specialist.

Maintaining good airflow

- Cleaning your lint screen before each load.
- Replace plastic or foil vent material with 4" (102 mm) diameter heavy, rigid vent material.

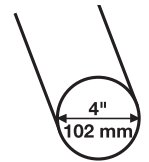

- Use the shortest length of vent possible.
- Use no more than four 90° elbows in a vent system; each bend and curve reduces airflow.

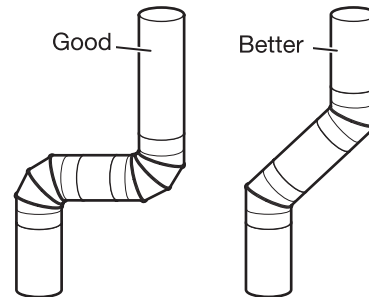

- Remove lint and debris from the exhaust hood.
- Remove lint from the entire length of the vent system at least every 2 years. When cleaning is complete, be sure to follow the Installation Instructions supplied with your dryer for final product check.
- Clear away items from the front of the dryer.

EcoBoost™ option

The EcoBoost™ option will default on only for the Regular/Normal cycle and is only available on that cycle.

This option allows you to increase your energy savings by using a slightly lower heat level. The EcoBoost™ option will increase drying times by approximately 40 minutes, which will be reflected on the LED Display. If optimal time is desired, touch ECOBOOST to turn off this option.

Use automatic cycles for better fabric care and energy savings

Using automatic (not timed) cycles, the drying air temperature and moisture levels are sensed in the load. This sensing process occurs throughout the entire drying cycle and turns off once the load reaches your selected dryness level. Using the NORMAL dryness level provides the optimal energy savings.

When using Timed Dry/Quick Dry, the dryer runs for the amount of time you select, which could result in shrinkage, wrinkling, and static due to over-drying. Use Timed Dry for the occasional damp load that needs a little more drying time or when using the drying rack.

Tips for getting the best performance from your steam dryer (on some models)

- Results may vary depending on fabric. 100% cotton garments with wrinkle-free finish may yield better results than those without. 100% cotton items may require additional touching up after cycles that use steam.
- Use of fabric softener sheet is not recommended with cycles that use steam. It may cause temporary staining on clothes.
- Cycles that use steam are not recommended for items that have been starched. Wash any starched or new garments prior to using a cycle that uses steam.
- The Steam Refresh Cycle is best for smoothing out wrinkles and reducing odors from loads consisting of dry items of wrinkle-free cotton, cotton-polyester blend, common knits, and synthetics.

CONTROL PANEL AND FEATURES

Not all features and cycles are available on all models.

NOTE: The control panel features a sensitive surface that responds to a light touch of your finger. To ensure your selections are registered, touch the control panel with your fingertip, not your fingernail. When selecting a setting or option, simply touch the appropriate button.

STEAM MODELS

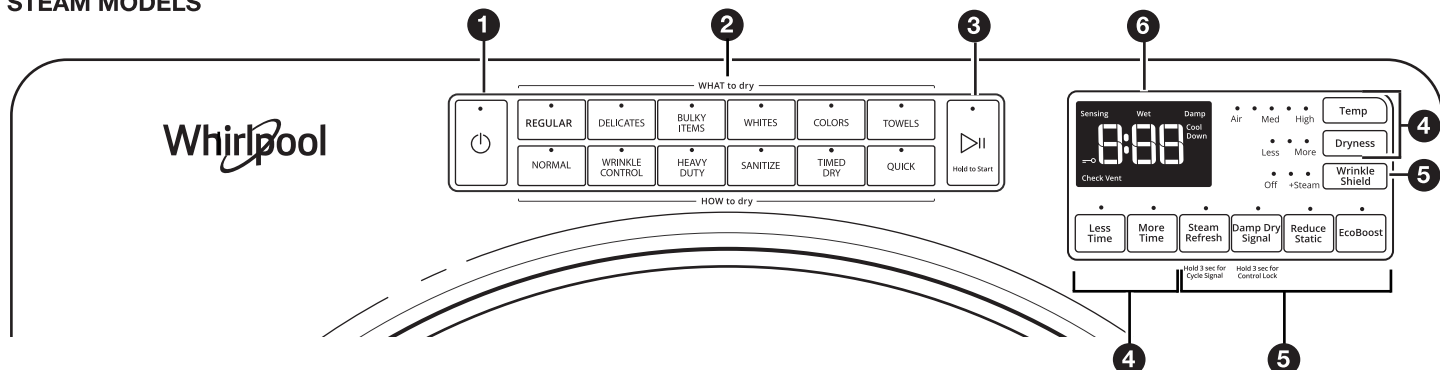

NON-STEAM MODELS

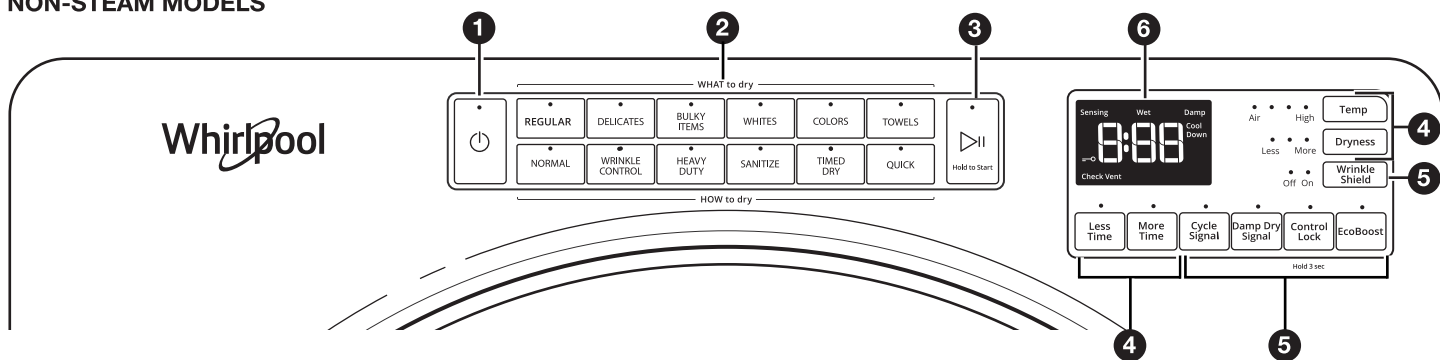

1 POWER

Touch to turn the dryer on and off. Touch to stop/cancel a cycle at any time.

2 WHAT TO DRY/HOW TO DRY

Once a “What to Dry” is selected, the dryer automatically selects the recommended or last-used “How to Dry” option, as well as the recommended/last-used modifiers. Both the “How to Dry” and modifiers can be changed if desired. See the “Cycle Guide” for details.

3 START/PAUSE

Touch and hold until LED counts down “3-2-1” and the dryer starts; then let go to start a cycle, or touch once while a cycle is in process to pause it.

4 MODIFIERS

Use to select available modifiers for your dryer. Not all cycles and options are available on all models.

Temp

When using Timed Dry/Quick Cycle, you may select a dry temperature based on the type of load you are drying. Use the warmest setting that is safe for the garments in the load. Follow garment label instructions.

NOTE: Automatic Cycles will give you up to four temperatures to adjust, depending on the model and the “What to Dry” or “How to Dry” selections that have been made.

Dryness

You may adjust the Dryness on Automatic Cycles (except for the Sanitize cycle), if desired.

NOTE: Dryness is for use with Automatic Cycles only.

More Time/Less Time Timed Dry Adjust

Touch MORE TIME or LESS TIME with the Timed Dry/Quick cycle to increase or decrease the length of the cycle.

5 OPTIONS

Use to select available options for your dryer. Not all cycles and options are available on all models.

Wrinkle Shield™ Option

If you will be unable to remove a load immediately, touch WRINKLE SHIELD™ to add up to 150 minutes of periodic tumbling to help reduce wrinkling. You may select the “+ Steam” setting (on some models) to add a short steam cycle after 60 minutes to help smooth out wrinkles.

NOTE: If you open the dryer door prior to the end of the Wrinkle Shield™ option, the dryer will go into standby.

Steam Refresh (steam models only)

This cycle is best for reducing wrinkles and odors from dry items. Cycle time will increase, depending on number of items. This is an independent cycle that cannot be combined with any other cycle.

Cycle Signal

Use this option to turn the signal indicating the end of a drying cycle to low, medium, high, or off. The volume you select here will also be applied to the Damp Dry Signal.

NOTE: You may also turn off the tones that sound when a feature, setting, or option is touched. Touch and hold CYCLE SIGNAL for about 3 seconds to turn sounds to low, medium, high, or off.

Damp Dry Signal

Touch to turn the Damp Dry Signal on or off. When selected, a series of beeps will sound when the load is damp, but not completely dry. This will allow you to take clothes out of the load that do not need to dry completely. This option is available on some cycles. The Damp Dry signal is selected as a default for the Bulky Items/Normal, Bulky Items/Wrinkle Control, and Bulky Items/Heavy Duty cycles, as a reminder to manually reposition bulky loads midway through the cycle.

Reduce Static (on some models)

Touch to add the Reduce Static option to selected Automatic cycles. The dryer will automatically tumble, pause, and introduce a small amount of moisture into the load to help reduce static. This option adds approximately 3 minutes to the total cycle time.

Control Lock

Use this option to lock the controls of the dryer and avoid an accidental change in cycle options or preferences during a drying cycle.

Touch and hold CONTROL LOCK or DAMP DRY SIGNAL (depending on the model) for 3 seconds to lock or unlock the controls of the dryer. During this time, the LED Display will count down "3-2-1." Once the controls are locked, the LED Display will display "Loc."

NOTE: The Control Lock function may be enabled when recovering from a power failure. To unlock the control, touch and hold CONTROL LOCK or DAMP DRY SIGNAL (depending on the model) for at least 3 seconds.

EcoBoost™ Option

The EcoBoost™ option will default on only for the Regular/Normal cycle and is only available on that cycle. This option allows you to increase your energy savings by using a slightly lower heat level. The EcoBoost™ option will increase drying times by approximately 40 minutes, which will be reflected on the LED Display. If optimal time is desired, touch ECOBOOST to turn off this option.

Wet

The load is still wet and/or the cycle just started.

Damp

This indicator shows that the load is partially dried and items that you may wish to hang up or iron while still damp may be removed.

Cool Down

The dryer has finished drying with heat and is now tumbling the load without heat to cool it down.

Check Vent

The Check Vent indicator is a feature available for Automatic cycles only. This indicator will show the status of airflow through the dryer and the dryer vent system for the dryer's life. During the sensing phase at the beginning of the cycle, the Check Vent light will come on if a blocked vent or low airflow issue is detected. This light will stay on for the entire cycle. Should the Check Vent light illuminate, refer to the "Troubleshooting" section for potential solutions to the issue.

The light will be cleared upon completion of the cycle, touching Power, or opening the door. The Check Vent light will continue to illuminate during the cycle unless the root cause is resolved.

REMEMBER: The dryer will continue to operate even while the indicator is lit, but poor airflow can impact dry times and overall performance. For more information on maintaining good airflow, see "Check Your Vent System for Good Airflow."

NOTE: If there are other error issues during a cycle, the Check Vent indicator will not light up. See the "Troubleshooting" section.

End

This will indicate that the selected cycle has ended and the load may be removed from the dryer. If Wrinkle Shield™ has been selected, the dryer may continue to tumble the load, even if "End" is displayed.

Control Lock

This will illuminate once the controls are locked.

6 LED DISPLAY

When you select a cycle, its default settings will light up and the Estimated Time Remaining (for Automatic Cycles) will vary depending on "What to Dry" and "How to Dry" selections, or actual time remaining for Timed Dry cycles (for Manual Cycles) will be displayed.

CYCLE STATUS INDICATORS



The Cycle Status Indicators show the progress of a cycle. Not all indicators are available on all models.

Sensing

The Sensing indicator will light periodically during Sensor Cycles to indicate that the moisture sensor on the dryer is operating. This indicator will not light during Timed Cycles or options such as Wrinkle Shield™.

CYCLE GUIDE

Your dryer has a unique user interface to help you select the best cycle you need for your load. The “What to Dry” “How to Dry” layout guides you to the optimal cycle in two easy steps:

1. First determine what items are in the load that you are trying to dry. Use that to guide your “What to Dry” selection.
2. Then determine how you want the dryer to dry them by selecting the appropriate “How to Dry” selection. Modifiers are preset for the items being dried, but can be changed if desired.

To get the most energy savings and enhanced fabric care from your dryer, use the Automatic cycles. These cycles measure the drying air temperature and moisture levels to turn the dryer off once the load reaches the selected dryness level. Dryer performance and results may vary with service voltage less than 240.

For best fabric care, choose the cycle that best fits the load being dried.

R – Recommended Cycle

a – Alternate Cycle

Blank – Cycle is available but not optimal.

How do you want to dry?					
“How to Dry” Cycle Selection					
Normal	Wrinkle Control	Heavy Duty	Sanitize*	Timed Dry	Quick
<i>Regular Automatic Sensor Cycle stops when dryness level is reached.</i>		<i>High Heat longer cycle Automatic Sensor Cycle stops when dryness level is reached.</i>	<i>Hot High Heat Used to kill 99.9% of three common bacteria.</i>	<i>Set amount of dry time Dryer runs for the amount of time selected.</i>	<i>Set amount of dry time Dryer runs for the amount of time selected.</i>

What do you want to dry?	“What to Dry” Cycle Selection	Normal	Wrinkle Control	Heavy Duty	Sanitize*	Timed Dry	Quick
Baby Clothes	Regular	R					
Pajamas		R					
Handkerchiefs		a			R		
T-Shirts		R					
Sweatshirts		a		R			
Jeans		a		R			
Cotton Drapes				R			
Machine Wash Curtains				R			
Tablecloth		R		a			
Business Casual				R			
No-Iron Fabrics				R			
Bras	Delicates	a	R				
Fabric Shower Curtain			R				
Lingerie		a	R				
Sheers			R				
Undergarments		a	R				
Wool			R				
Dress Shirts/Pants		a	R				
Blankets	Bulky Items	R		a			
Fabric Rugs		R					
Heavy Drapes		a		R			
Coats and Jackets		a		R			
Comforters		R		a			
Pet Bedding		a		R			
Pillows - Fiber Fill		a		R			
Sheets		R		a			
Sleeping Bags		R					
Stuffed Animals				R			

*Extended high-heat drying cycle intended to help sanitize items such as sheets and towels. This cycle is not recommended for all fabrics. For best results, this cycle should be run to completion to ensure sanitization and do not interrupt cycle.

For best fabric care, choose the cycle that best fits the load being dried.

R – Recommended Cycle

a – Alternate Cycle

Blank – Cycle is available but not optimal.

How do you want to dry?					
“How to Dry” Cycle Selection					
Normal	Wrinkle Control	Heavy Duty	Sanitize*	Timed Dry	Quick
<i>Regular Automatic Sensor Cycle stops when dryness level is reached.</i>		<i>High Heat longer cycle Automatic Sensor Cycle stops when dryness level is reached.</i>	<i>Hot High Heat Used to kill 99.9% of three common bacteria.</i>	<i>Set amount of dry time Dryer runs for the amount of time selected.</i>	<i>Set amount of dry time Dryer runs for the amount of time selected.</i>

What do you want to dry?	“What to Dry” Cycle Selection	Normal	Wrinkle Control	Heavy Duty	Sanitize*	Timed Dry	Quick
Cotton Undergarments	Whites	R	a				
White Napkins		R	a				
Athletic	Colors	R	a				
Performance Wear		R	a				
Colored Napkins		R	a				
Dish Cloths	Towels	a		R	a		
Towels		a		R	a		
Non-Rubber Lined Rugs			R				

*Extended high-heat drying cycle intended to help sanitize items such as sheets and towels. This cycle is not recommended for all fabrics. For best results, this cycle should be run to completion to ensure sanitization and do not interrupt cycle.

NOTE: Government energy certifications for this model were based on the Regular + Normal Cycle, Highest Temperature Setting, Normal Dryness Level, EcoBoost On. The as-shipped defaults were the same as the Government Energy Certification Settings except the default Temperature Setting of Medium was adjusted to the Highest Temperature Setting.

USING YOUR DRYER

⚠️ WARNING



Explosion Hazard

Keep flammable materials and vapors, such as gasoline, away from dryer.

Do not dry anything that has ever had anything flammable on it (even after washing).

Failure to follow these instructions can result in death, explosion, or fire.

WARNING: To reduce the risk of fire, electric shock, or injury to persons, read the Important Safety Instructions before operating this appliance.

⚠️ WARNING



Fire Hazard

No washer can completely remove oil.

Do not dry anything that has ever had any type of oil on it (including cooking oils).

Items containing foam, rubber, or plastic must be dried on a clothesline or by using an Air Cycle.

Failure to follow these instructions can result in death or fire.

1. Clean the lint screen

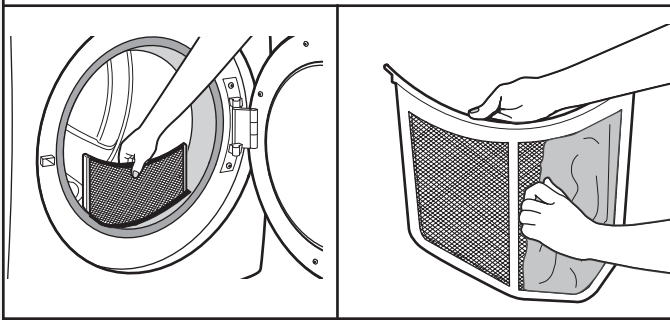

Clean the lint screen before each load. Pull the lint screen straight up. Roll lint off the screen with your fingers. Do not rinse or wash screen to remove lint. Wet lint is hard to remove. Push the lint screen firmly back into place. For additional cleaning information, see "Dryer Care."

2. Load the dryer

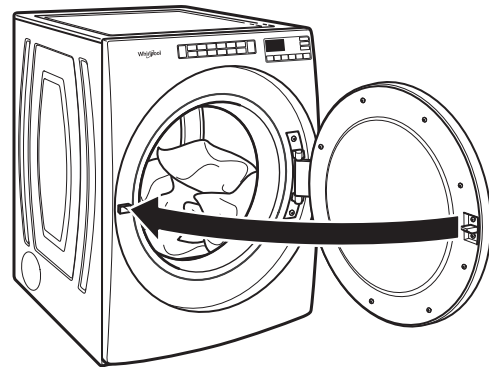

Open the door by pulling on the handle. Place laundry in the dryer. Add a dryer sheet to wet load, if desired. Close the door.

IMPORTANT: Do not tightly pack the dryer. Items need to tumble freely. Tightly packing can lead to poor drying performance and may increase wrinkling and tangling.

3. Touch POWER

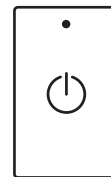

Touch POWER to turn on the dryer.

4. Select type of load to dry

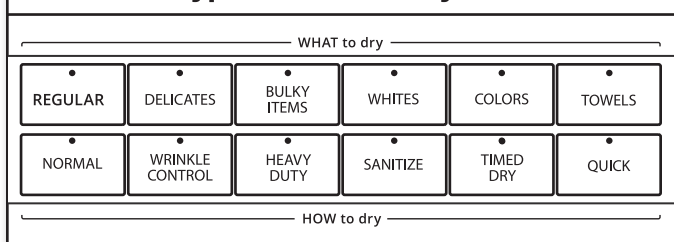

First select a cycle from the “What to Dry” (Automatic cycles) options; then select a “How to Dry” option to get the best combination cycle available for the type of items you are going to dry. You may also select the Sanitize cycle for a long, high-heat cycle which has been proven to reduce household bacteria. The Sanitize cycle overrides previous selections and cannot be modified. See “Cycle Guide” for cycle details. Not all cycles are available on all models.

Automatic Cycles:

You can select a different dryness level, depending on your load. Touch DRYNESS to scroll to Less to More. Selecting Less to More automatically adjusts the dryness level at which the dryer will shut off. Dryness level can be changed in the first 5-8 minutes of the cycle.

Automatic Cycles give the best drying in the shortest time. Drying time varies based on fabric type, load size, and dryness setting.

NOTE: Automatic Cycles will give you up to four temperatures to adjust, depending on the model and the “What to Dry” or “How to Dry” selections that have been made.

TIMED DRY Cycle:

When you select Timed Dry/Quick, the default time appears in the display. Touch MORE TIME or LESS TIME to increase or decrease the time in 5-minute increments.

The default temperature may be changed by touching Temp until the desired dry temperature is lit.

Steam Refresh Cycles (on some models):

Select Steam Refresh to reduce odors and light wrinkles in dry loads consisting of wrinkle-free cotton, cotton-polyester blends, common knits, and synthetics. If you will be unable to remove a load immediately, touch WRINKLE SHIELD™ to add up to 150 minutes of periodic tumbling. You may select the + Steam setting to add a short steam cycle after 60 minutes to help smooth out wrinkles.

5. Adjust cycle modifiers, if desired

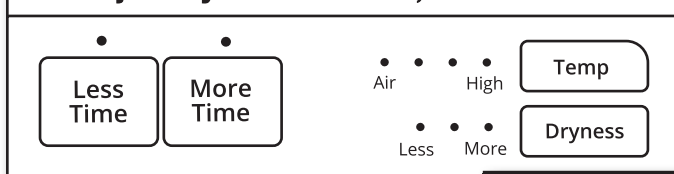

You may adjust different settings, depending on what you are drying and how you are going to dry the item. Use Air Dry for items like feather pillows, plastic shower curtains, rubber-backed rugs and mats and vinyl tablecloths.

NOTE: Not all options and modifiers are available with all cycles. Not all cycles are on all models.

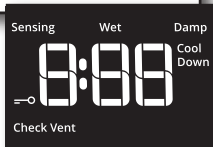

6. Select any additional options

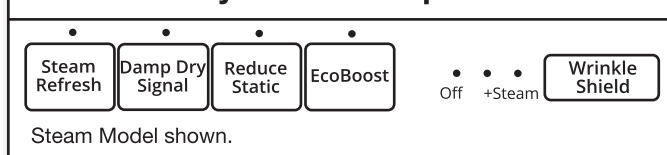

Add additional options such as Reduce Static, Wrinkle Shield™, and/or EcoBoost™ (on some models) by touching that option. If you will be unable to remove the load promptly, select Wrinkle Shield™ before touching START/PAUSE. You may select the “+ Steam” setting (on some models) to add a short steam cycle after 60 minutes to help smooth out wrinkles.

NOTE: Not all options and settings are available with all cycles.

7. Touch and hold START/PAUSE to begin cycle

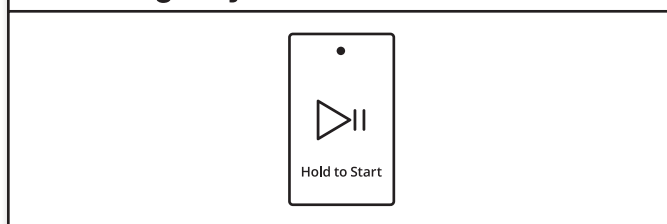

To begin the cycle, touch and hold START/PAUSE until the display counts down “3-2-1” and the dryer starts.

8. Remove garments promptly after cycle is finished

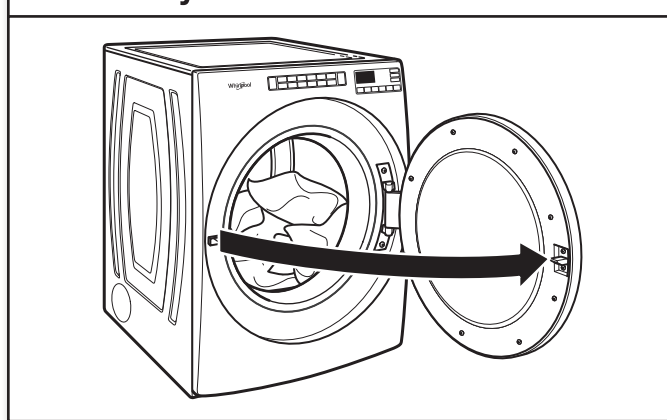

Promptly remove garments after cycle has completed to reduce wrinkling.

ADDITIONAL FEATURES

USING THE DRYING RACK (some models)

Use the Drying Rack for items that you do not want to tumble dry, such as sweaters and tennis shoes. When you use the drying rack, the drum continues to turn, but the rack remains stationary.

The drying rack is intended for use with the Manual Dry/ Timed Dry cycles only. The drying rack cannot be used with Automatic cycles.

To use the drying rack:

IMPORTANT: Do not remove the lint screen.

1. Open dryer door.

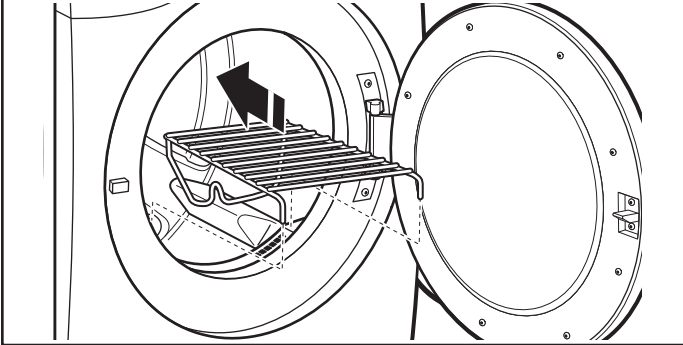

USING THE DRYING RACK (cont.)

2. Align the two hooks on the front of the drying rack with the holes in the dryer door opening and press down fully into holes. Rest the rear support on the dryer back ledge.

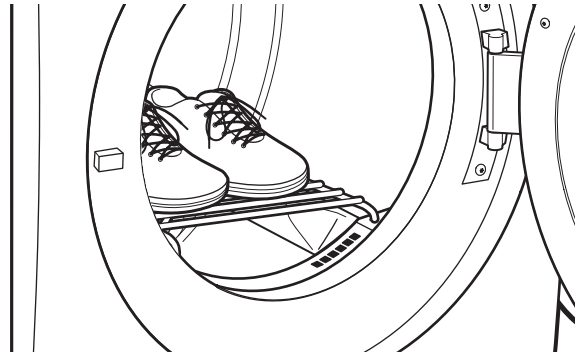

3. Place wet items on top of the drying rack. Allow space around items for air to circulate. The drying rack does not move, but the drum will rotate; be sure to leave adequate clearance between items and the inside of the dryer drum. Make sure items do not hang over the edges or between drying rack grille.
4. Close the door.
5. Select a Timed Dry/Air Only, or Low Temperature cycle. Items containing foam, rubber, or plastic must be dried on a clothesline or by using the Air Only setting.
6. When the cycle is selected, the Estimated Time Remaining display shows the default time. You can change the actual time in the cycle by increasing or decreasing the cycle time.
7. Start the dryer.

NOTE: Check the lint screen and remove any lint accumulated from items dried on the drying rack after the cycle is finished.

DRYER CARE

CLEANING THE DRYER LOCATION

Keep dryer area clear and free from items that would block the airflow for proper dryer operation. This includes clearing piles of laundry in front of the dryer.

⚠ WARNING



Explosion Hazard

Keep flammable materials and vapors, such as gasoline, away from dryer.

Place dryer at least 18 inches (460 mm) above the floor for a garage installation.

Failure to do so can result in death, explosion, or fire.

CLEANING THE DRYER INTERIOR

To clean dryer drum

1. Use a mild hand dish detergent mixed at a low concentration with very warm water, and rub with a soft cloth.
2. Rinse well with a wet sponge or towel.
3. Tumble a load of clean clothes or towels to dry drum
OR
Use a microfiber cloth and hot water in a spray bottle to clean the drum and a second microfiber towel to dry.

NOTE: Garments that contain unstable dyes, such as denim blue jeans or brightly colored cotton items, may discolor the rear of the dryer interior. These stains are not harmful to your dryer and will not stain future loads of clothes. Dry unstable dye items inside out to avoid transfer of dye.

REMOVING ACCUMULATED LINT

From Inside the Dryer Cabinet

Lint should be removed every 2 years, or more often, depending on dryer usage. Cleaning should be done by a qualified appliance servicer or ventilation system cleaner.

From the Exhaust Vent

Lint should be removed every 2 years, or more often, depending on dryer usage.

CLEANING THE LINT SCREEN

Every load cleaning

The lint screen is located in the door opening of the dryer. The control panel has an indicator light "Check Lint" to remind you to clean the lint screen after each load. A screen blocked by lint can increase drying time.

To clean:

1. Pull the lint screen straight up. Roll lint off the screen with your fingers. Do not rinse or wash screen to remove lint. Wet lint is hard to remove.

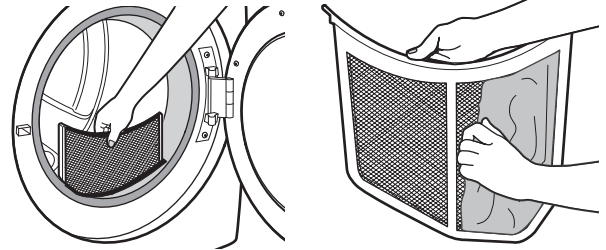

2. Push firmly back into place.

IMPORTANT:

- Do not run the dryer with the lint screen loose, damaged, blocked, or missing. Doing so can cause overheating and damage to both the dryer and fabrics.
- If lint falls off the screen into the dryer during removal, check the exhaust hood and remove the lint. See "Venting Requirements" in the Installation Instructions.

As-needed cleaning

Laundry detergent and fabric softener residue can build up on the lint screen. This buildup can cause longer drying times for your clothes, or cause the dryer to stop before your load is completely dry. The screen is probably clogged if lint falls off while the screen is in the dryer.

Clean the lint screen with a nylon brush every 6 months, or more frequently, if it becomes clogged due to a residue buildup.

To wash:

1. Roll lint off the screen with your fingers.
2. Wet both sides of lint screen with hot water.
3. Wet a nylon brush with hot water and liquid detergent. Scrub lint screen with the brush to remove residue buildup.

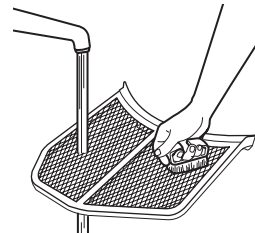

4. Rinse screen with hot water.
5. Thoroughly dry lint screen with a clean towel. Reinstall screen in dryer.

NON-USE, STORAGE, AND MOVING CARE

Steam models only: Install and store your dryer where it will not freeze. Because some water may stay in the hose, freezing can damage your dryer. If storing or moving your dryer during freezing weather, winterize it.

Non-Use or Storage Care

Operate your dryer only when you are at home. If you will be on vacation or not using your dryer for an extended period of time, you should:

1. Unplug dryer or disconnect power.
2. Clean lint screen. See "Cleaning the Lint Screen."
3. Turn off the water supply to the dryer. This helps to avoid unintended flooding (due to a water pressure surge) while you are away.

Moving Care

For power supply cord-connected dryers:

1. Unplug the power supply cord.
2. Gas models only: Close shut-off valve in gas supply line.
3. Gas models only: Disconnect gas supply line pipe and remove fittings attached to dryer pipe.
4. Gas models only: Cap the open fuel supply line.
5. Steam models only: Shut off water faucet.
6. Disconnect the water inlet hose from faucet, then drain the hose. Transport hose separately.
7. Make sure leveling legs are secure in dryer base.
8. Use tape to secure dryer door.

SPECIAL INSTRUCTIONS FOR STEAM MODELS

Water Inlet Hose

Replace inlet hose and hose screen after 5 years of use to reduce the risk of hose failure. Periodically inspect and replace inlet hose if bulges, kinks, cuts, wear, or leaks are found.

When replacing your inlet hose, record the date of replacement.

To Winterize the Dryer

1. Unplug dryer or disconnect power.
2. Shut off water faucet.
3. Disconnect water inlet hose from faucet and drain.

To Use the Dryer Again

1. Flush water pipes. Reconnect water inlet hose to faucet. Turn on water faucet.
2. Plug in dryer or reconnect power as described in the Installation Instructions.

⚠ WARNING



Electrical Shock Hazard

Disconnect power before servicing.

Replace all parts and panels before operating.

Failure to do so can result in death or electrical shock.

For direct-wired dryers:

1. Disconnect power.
2. Disconnect wiring.
3. Steam models only: Shut off water faucet.
4. Steam models only: Disconnect the water inlet hose from faucet; then drain the hose. Transport hose separately.
5. Make sure leveling legs are secure in dryer base.
6. Use tape to secure dryer door.

Reinstalling the Dryer

Follow the Installation Instructions to locate, level, and connect the dryer.

TROUBLESHOOTING

First try the solutions suggested here or visit our website at www.whirlpool.com/owners (in Canada www.whirlpool.ca/owners) for assistance and to possibly avoid a service call.

If you experience	Possible Causes	Solution
Dryer Operation		
Dryer will not run	Door not closed completely.	Make sure the dryer door is closed completely.
	Start/Pause touched with fingernail.	Touch START/PAUSE with pad of finger.
	Household fuse is blown or circuit breaker has tripped.	There may be two household fuses or circuit breakers for the dryer. Check that both fuses are intact and tight, or that both circuit breakers have not tripped. Replace the fuses or reset the circuit breaker. If the problem continues, call an electrician.
	Incorrect power supply.	Electric dryers require 240 V power supply. Check with a qualified electrician.
	Wrong type of fuse.	Use a time-delay fuse.
Dryer will not turn off	Dryer door was opened prior to the end of the Wrinkle Shield™ option.	If you open the dryer door prior to the end of the Wrinkle Shield™ option, the dryer will go into Pause mode. You will need to touch Power to turn off or touch Start/Pause to continue Wrinkle Shield™ option.
Dryer will not heat	Household fuse is blown or circuit breaker has tripped.	The drum may be turning, but you may not have heat. Electric dryers use two household fuses or circuit breakers. Replace the fuses or reset the circuit breaker. If the problem continues, call an electrician.
	Incorrect power supply.	Electric dryers require 240 V power supply. Check with a qualified electrician.
	Supply line valve not open.	For gas dryers, make sure that the valve on the gas supply line is open.
Unusual Noise		
Humming or whining noise with Steam cycle selected (on some models)	Water pump or water inlet valve (depending on model) on dryer is running.	The water pump on the dryer is used during the Steam function. If the dryer has just been installed or unused for an extended period, the pump may be louder and run longer. This is normal. NOTE: The valve may make this noise even with no water line connected.
Thumping noise	Dryer hasn't been used in a while.	This is normal. The thumping sound should diminish after a few minutes of use.
Rattling or vibrating noise	A small object caught between the edges of dryer drum.	Check the front and rear edges of the drum for small objects. Clean out pockets before laundering.
	Dryer isn't properly leveled.	The dryer may vibrate if not properly installed. See the Installation Instructions. All four dryer feet should be in firm contact with the floor.
	Clothing is balled up in dryer.	When balled up, the load will bounce, causing the dryer to vibrate. Separate the load items and restart the dryer.
Clicking noise	Gas valve operating.	On gas dryers, you may hear the gas valve clicking as it opens and closes. This is normal.
Dryer Results		
Drying times are too long and clothes are not getting dry	Lint screen is clogged with lint.	Clean lint screen before each load.
	EcoBoost™ option is on.	For optimal dry times, turn off the EcoBoost™ option.
	The exhaust vent or outside exhaust hood is clogged with lint, restricting air movement.	Run the dryer for 5–10 minutes. Hold your hand under the outside exhaust hood to check air movement. If you do not feel air movement, clean exhaust system of lint or replace exhaust vent with heavy metal or flexible metal vent. See the Installation Instructions.
	The exhaust vent is not the correct length.	Check that the exhaust vent is not too long or has too many turns. Long venting will increase drying times. See the Installation Instructions.
	The exhaust vent diameter is not the correct size.	Use 4" (102 mm) diameter vent material.

TROUBLESHOOTING

First try the solutions suggested here or visit our website at www.whirlpool.com/owners
(in Canada www.whirlpool.ca/owners) for assistance and to possibly avoid a service call.

If you experience	Possible Causes	Solution
Dryer Results (cont.)		
Drying times are too long and clothes are not getting dry (cont.)	The dryer is not level.	Clothes not contacting the moisture sensors during Automatic cycles. See "Level Dryer" in the Installation Instructions.
	The Air Only temperature setting has been selected.	Select the correct temperature for the types of garments being dried. See "Cycle Guide."
	The load is too large and heavy to dry quickly.	Separate the load to tumble freely.
	Fabric softener sheets are blocking the grille.	The air outlet grille is just inside the door, behind the lint screen. Check that it is not blocked by a fabric softener sheet. Use only one fabric softener sheet, and use it only once.
	The dryer is located in a room with temperature below 45°F (7°C).	Proper operation of dryer cycles requires temperatures above 45°F (7°C).
	The dryer is located in a closet.	Closet doors must have ventilation openings at the top and bottom of the door. The front of the dryer requires a minimum of 1" (25 mm) of airspace, and, for most installations, the rear of the dryer requires 5" (127 mm). See the Installation Instructions.
Cycle time is too short	The load may not be contacting the sensor strips on Automatic Cycles.	Level the dryer. See the Installation Instructions. All four dryer feet should be in firm contact with the floor.
	Steam models only: Clothes are coming out of the Steam Refresh cycle with damp or wet spots.	Under certain environmental or installation conditions, you may experience underdrying.
	The automatic cycle is ending early.	Change the dryness level setting on Automatic Cycles. Increasing or decreasing the dryness level will change the amount of drying time in a cycle.
Lint on load	Lint screen is clogged with lint.	Clean lint screen before each load.
Stains on load	Improper use of fabric softener.	Add dryer fabric softener sheets at the beginning of the cycle. Fabric softener sheets added to a partially dried load can stain your garments. Do not use fabric softener sheets with steam cycles.
Stains on drum	Loose dyes in clothes.	Drum stains are caused by dyes in clothing (usually blue jeans). These will not transfer to other clothing.
Loads are wrinkled	The load was not removed from dryer at the end of the cycle.	Steam models only: Select Steam Refresh cycle to tumble the load with water and heat. This cycle is best for smoothing out wrinkles and reducing odors from dry loads consisting of wrinkle-free cotton, cotton-polyester blends, common knits, and synthetics. NOTE: Refer to garment care label instructions. Dry-clean-only garments are not recommended.
	The dryer was tightly packed.	Dry smaller loads that can tumble freely. Results may also vary depending on fabric type.
	Steam models only: For steam cycles, the water is not properly connected with the dryer.	Steam models only: Make sure water is connected to the dryer. Check that water inlet hose is connected to both the faucet and dryer's water inlet valve. Check that the water supply is turned on.
Odors	Recent painting, staining, or varnishing in the area where your dryer is located.	Ventilate the area. When the odors or fumes are gone from the area, rewash and dry the clothing.

TROUBLESHOOTING

First try the solutions suggested here or visit our website at www.whirlpool.com/owners
(in Canada www.whirlpool.ca/owners) for assistance and to possibly avoid a service call.

If you experience	Possible Causes	Solution
Dryer Results (cont.)		
Odors (cont.)	Steam models only: For steam cycles, the water is not properly connected with the dryer.	Make sure water is connected to the dryer. Check that water inlet hose is connected to both the faucet and dryer's water inlet valve. Check that the water supply is turned on.
	Odors are left in garments after wearing.	To remove odors left in garments after wearing, select Steam Refresh. This cycle is best for reducing wrinkles and odors from dry loads consisting of wrinkle-free cotton, cotton-polyester blends, common knits, and synthetics.
Load too hot	Load removed before cooldown portion of cycle complete.	Allow the dryer to complete the cooldown portion of the cycle before removing the load.
	Using Timed Dry cycle with a high temperature setting.	Select an Automatic Cycle with a lower heat setting to avoid overdrying the load.
Dryer Displaying Code Message or Indicator Is Lit		
"PF" (power failure)	The drying cycle has been interrupted by a power failure.	Touch POWER to clear the display.
"L2" Diagnostic Code (low or no line voltage condition)	There may be a problem with your home power supply, keeping the dryer's heater from turning on.	The dryer will continue to run when this diagnostic code is present. Touch any pad to clear the code from the display and return to the estimated time remaining. NOTE: This error will only show during the initial installation. Try the following: <ul style="list-style-type: none"> • Check to see if a household fuse has blown or circuit breaker has tripped. Electric dryers use two household fuses or breakers. Replace the fuse or reset the circuit breaker. • Confirm that the power cord is properly installed. Refer to the Installation Instructions for details. • Select a Timed Dry heated cycle, and restart the dryer. If the message persists, consult a qualified electrician.
"F# E#" (F1 E1, F3 E1, etc.) variable service codes.	The dryer is in need of service.	If a code beginning with an "F" appears in the display, alternating between F# and E#, the dryer control has detected a problem that requires service. Call for service.
Check Vent indicator is lit	The lint screen or vent is clogged; the vent is crushed or kinked or has too many turns.	The dryer will continue to run when this indicator is lit. Try the following: <ul style="list-style-type: none"> • Clean lint screen. • Check to see if the vent run from the dryer to the wall is crushed or kinked. • Confirm that the vent run from the dryer to the wall is free of lint and debris. • Confirm that the exterior vent exhaust hood is free of lint and debris. • Confirm that your vent system falls within the recommended run length and number of elbows for the type of vent you are using. Refer to "Plan Vent System" in the Installation Instructions for details. • Select a Timed Dry heated cycle, and restart the dryer. • If the indicator remains lit, have your entire home venting run cleaned.
"Loc"	The Control Lock is enabled.	Touch and hold CONTROL LOCK or DAMP DRY SIGNAL (depending on the model) for 3 seconds to unlock the controls of the dryer. During this time, the LED Display will count down "3-2-1." When the Control Lock is disabled, the LED Display will clear.

WHIRLPOOL® LAUNDRY LIMITED WARRANTY

ATTACH YOUR RECEIPT HERE. PROOF OF PURCHASE IS REQUIRED TO OBTAIN WARRANTY SERVICE. Please have the following information available when you call the Customer eXperience Center:

- Name, address, and telephone number
- Model number and serial number
- A clear, detailed description of the problem
- Proof of purchase including dealer or retailer name and address

IF YOU NEED SERVICE:

1. Before contacting us to arrange service, please determine whether your product requires repair. Some questions can be addressed without service. Please take a few minutes to review the Troubleshooting section of the Use and Care Guide or visit the "HOW-TOS & FAQs" section of <https://www.whirlpool.com/owners.html>.
2. All warranty service is provided exclusively by our authorized Whirlpool Service Providers.

In the U.S. and Canada, direct all requests for warranty service to:

Whirlpool Customer eXperience Center

In the U.S.A. call 1-866-698-2538. In Canada call 1-800-807-6777.

If outside the 50 United States and Canada, contact your authorized Whirlpool dealer to determine if another warranty applies.

ONE YEAR LIMITED WARRANTY

WHAT IS COVERED

For one year from the date of purchase, when this major appliance is installed, operated, and maintained according to instructions attached to or furnished with the product, Whirlpool Corporation or Whirlpool Canada LP (hereafter "Whirlpool") will pay for Factory Specified Replacement Parts and repair labor to correct defects in materials or workmanship that existed when this major appliance was purchased, or at its sole discretion replace the product. In the event of product replacement, your appliance will be warranted by the remaining term of the original unit's warranty period.

YOUR SOLE AND EXCLUSIVE REMEDY UNDER THIS LIMITED WARRANTY SHALL BE PRODUCT REPAIR AS PROVIDED HEREIN. Service must be provided by a Whirlpool designated service company. This limited warranty is valid only in the United States or Canada and applies only when the major appliance is used in the country in which it was purchased. This limited warranty is effective from the date of original consumer purchase. Proof of original purchase date is required to obtain service under this limited warranty.

WHAT IS NOT COVERED

1. Commercial, non-residential, multiple-family use, or use inconsistent with published user, operator, or installation instructions.
2. In-home instruction on how to use your product.
3. Service to correct improper product maintenance or installation, installation not in accordance with electrical or plumbing codes, or correction of household electrical or plumbing (e.g., house wiring, fuses, or water inlet hoses).
4. Consumable parts (e.g., light bulbs, batteries, air or water filters, preservation solutions).
5. Defects or damage caused by the use of non-genuine Whirlpool parts or accessories.
6. Conversion of your product from natural gas or propane gas or reversal of appliance doors.
7. Damage from accident, misuse, abuse, fire, floods, acts of God, or use with products not approved by Whirlpool.
8. Repairs to parts or systems to correct product damage or defects caused by unauthorized service, alteration, or modification of the appliance.
9. Cosmetic damage including scratches, dents, chips, and other damage to appliance finishes unless such damage results from defects in materials and workmanship and is reported to Whirlpool within 30 days.
10. Discoloration, rust, or oxidation of surfaces resulting from caustic or corrosive environments, including but not limited to, high salt concentrations, high moisture or humidity, or exposure to chemicals.
11. Pick-up or delivery. This product is intended for in-home repair.
12. Travel or transportation expenses for service in remote locations where an authorized Whirlpool servicer is not available.
13. Removal or reinstallation of inaccessible appliances or built-in fixtures (e.g., trim, decorative panels, flooring, cabinetry, islands, countertops, drywall) that interfere with servicing, removal, or replacement of the product.
14. Service or parts for appliances with original model/serial numbers removed, altered, or not easily determined.

The cost of repair or replacement under these excluded circumstances shall be borne by the customer.

DISCLAIMER OF IMPLIED WARRANTIES

IMPLIED WARRANTIES, INCLUDING ANY IMPLIED WARRANTY OF MERCHANTABILITY OR IMPLIED WARRANTY OF FITNESS FOR A PARTICULAR PURPOSE, ARE LIMITED TO ONE YEAR OR THE SHORTEST PERIOD ALLOWED BY LAW. Some states and provinces do not allow limitations on the duration of implied warranties of merchantability or fitness, so this limitation may not apply to you. This warranty gives you specific legal rights, and you also may have other rights that vary from state to state or province to province.

DISCLAIMER OF REPRESENTATIONS OUTSIDE OF WARRANTY

Whirlpool makes no representations about the quality, durability, or need for service or repair of this major appliance other than the representations contained in this Warranty. If you want a longer or more comprehensive warranty than the limited warranty that comes with this major appliance, you should ask Whirlpool or your retailer about buying an extended warranty.

LIMITATION OF REMEDIES; EXCLUSION OF INCIDENTAL AND CONSEQUENTIAL DAMAGES

YOUR SOLE AND EXCLUSIVE REMEDY UNDER THIS LIMITED WARRANTY SHALL BE PRODUCT REPAIR AS PROVIDED HEREIN. WHIRLPOOL SHALL NOT BE LIABLE FOR INCIDENTAL OR CONSEQUENTIAL DAMAGES. Some states and provinces do not allow the exclusion or limitation of incidental or consequential damages, so these limitations and exclusions may not apply to you. This warranty gives you specific legal rights, and you also may have other rights that vary from state to state or province to province.