



KM2 Series In-Wall Timers

Replaces standard wall switch to provide automatic control of outdoor or indoor lighting, fans, pumps, office machines, and other types of circuits. Captive trippers are easy to set, can't be lost. 72 trippers provide up to 36 ON/OFF events in 24 hour period. OFF/ON/AUTO override switch provides continuous ON or OFF positions. UL Listed. Easy wiring and installation.

FEATURES

- ★ 24 hour or 7 day time switch program
- ★ Captive trippers with 20 minute switching interval (2-1/3 hr. for 7 day)
- ★ Reliable synchronous timer motor
- ★ SPST or SPDT 20A, 1HP @ 120V switch
- ★ OFF/ON/AUTO    manual switch
- ★ Mounts to standard electrical wall boxes
- ★ Available with 1, 2, 3, or 4-gang wall plates with toggle switch openings, or 2-gang wall plates with either duplex receptacle or decorator opening
- ★ Three way (SPDT) switch available
- ★ Dual timer allows control of two separate circuits with different time schedules
- ★ UL and Canadian UL Listed

SPECIFICATIONS

Clock Input: 120VAC, 60Hz
 SPST and SPDT Switch Rating:
 20A @ 120VAC, 60Hz
 2400W Resistive
 8A Inductive
 1HP @ 120VAC
 1350W Tungsten

Environmental Ratings:

Operating Temperature Range:
 -40°F to 180°F (-40°C to 85°C)
 Operating Humidity: 0 - 95% RH,
 non-condensing

Wiring Connections: Three #14AWG lead wires

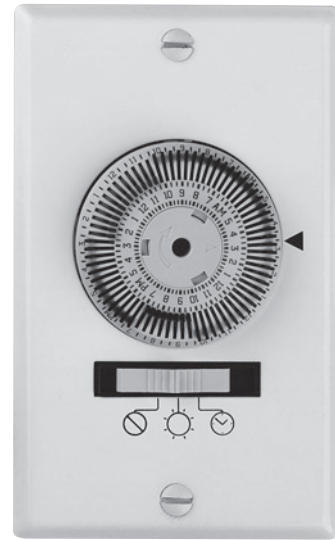

1-gang



2-gang/toggle



4-gang/toggle



2-gang/decorator



Dual Timer
(2-gang with 2 KM2's)

ORDERING DATA - 120V, 60Hz Models

24 Hour Model Code	7 Day Model Code	Description	Switch
KM2 ST-1G	KM2 SW-1G	single gang	20A, SPST
KM2 STu-1G	KM2 SWu-1G	three-way single gang	20A, SPDT
KM2 ST-2G	KM2 SW-2G	2-gang/toggle opening	20A, SPST
KM2 ST-2R	N/A	2-gang/receptacle opening	20A, SPST
KM2 ST-2D	KM2 SW-2D	2-gang/decorator opening	20A, SPST
KM2 ST-3D	N/A	3-gang/decorator opening	20A, SPST
KM2 ST-3G	N/A	3-gang/toggle openings	20A, SPST
KM2 ST-4G	N/A	4-gang/toggle openings	20A, SPST
KM2 STST-2G	KM2 SWSW-2G	2-gang/dual timer	(2) 20A, SPST



Installation

1. Read the operating instructions carefully.
2. Check the input and output ratings marked on the unit to make sure this product is suitable for your application.
3. Disconnect power supply prior to installation to prevent electrical shock.
4. Damage to the contacts caused by short circuiting will void warranty.
5. Wire in accordance with National and local electrical code requirements.

BE SURE ALL CONNECTIONS ARE SECURE. DOUBLE CHECK ALL TWIST-ON WIRE CONNECTORS.

6. Mount timer into wall box using supplied screws.
7. If timer does not operate, check that the timer's black wire is connected to hot line and not the load. If necessary, reverse connections to red and black wires.

Manual Operation

The slide switch provides manual operation of the load, overriding the timer. If set to the  position, the load will be continuously off, and if set to , it will be continuously on. For automatic timed on's and off's, the switch must be in the  position.

Programming

The timer dial contains 72 "trippers" which, when set at the inner perimeter of the dial, will turn the switch "ON" at the time adjacent to the tripper. The switch will return to the "OFF" position when the timer progresses past the inward trippers.

The 72 trippers allow multiple on/off sequences with a minimum on or off time of 20 min. To program, set all trippers inward for the duration of the on event.

For example, to turn lights on at 5:00pm and off at 11:00pm, leave inward the 18 trippers between 5 and 11 on the "pm" side of the dial. Make sure manual switch is in the  position.

NOTE: For any times where "OFF" programming is desired, the trippers must be moved to the outer perimeter of the dial.

Setting The Time

Rotate the dial *clockwise* until the correct time and "am" or "pm" is opposite the arrow on the plate.

CAUTION: Do not turn dial counter-clockwise, as the timer will be damaged.

ONE YEAR WARRANTY

If this unit fails due to a defect in material or workmanship within one year after purchase, Intermatic will repair or replace the unit free of charge. This warranty does not apply to damage due to accidents, abuse, mishandling nor to units not used in accordance with directions. This warranty gives you specific legal rights, and you may also have other rights which vary from state to state.

Wiring Diagrams

Standard Installation

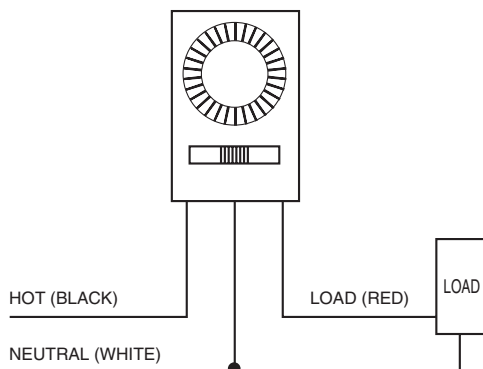

3-Way Installation

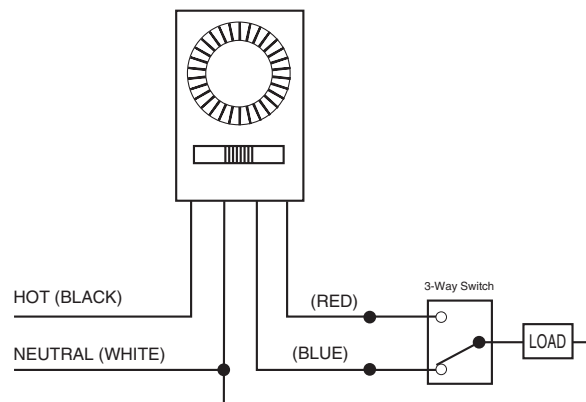

INTERMATIC INCORPORATED
Spring Grove, IL 60081-9698
www.intermatic.com

Distributed by: